



*"Improving the Quality of Life  
by Enhancing Mobility"*

**University Transportation Center for Mobility**

**DOT Grant No. DTRT06-G-0044**

# **Development of a Special Topics Course on Intelligent Transportation Systems for the Zachry Department of Civil Engineering of Texas A&M University**

## ***Final Report***

**Kevin N. Balke and Robert E. Brydia**

***Performing Organization***

University Transportation Center for Mobility  
Texas Transportation Institute  
The Texas A&M University System  
College Station, TX

***Sponsoring Agency***

Department of Transportation  
Research and Innovative Technology Administration  
Washington, DC



**UTCM Project #08-27-02  
August 31, 2009**

1. Project No. UTCM 08-27-02		2. Government Accession No.		3. Recipient's Catalog No.	
4. Title and Subtitle Development of a Special Topics Course on Intelligent Transportation Systems for the Zachry Department of Civil Engineering of Texas A&M University				5. Report Date August 31, 2009	
				6. Performing Organization Code Texas Transportation Institute	
7. Author(s) Kevin N. Balke and Robert E. Brydia				8. Performing Organization Report No. UTCM 08-27-02	
9. Performing Organization Name and Address University Transportation Center for Mobility Texas Transportation Institute The Texas A&M University System 3135 TAMU College Station, TX 77843-3135				10. Work Unit No. (TRAIS)	
				11. Contract or Grant No.  DTRT06-G-0044	
12. Sponsoring Agency Name and Address Department of Transportation Research and Innovative Technology Administration 400 7 <sup>th</sup> Street, SW Washington, DC 20590				13. Type of Report and Period Covered Final Report 1/1/08 – 6/30/09	
				14. Sponsoring Agency Code	
15. Supplementary Notes Supported by a grant from the US Department of Transportation, University Transportation Centers Program					
16. Abstract With Intelligent Transportation Systems (ITS), engineers and system integrators blend emerging detection/surveillance, communications, and computer technologies with transportation management and control concepts to improve the safety and mobility of the surface transportation system. Individuals responsible for developing, deploying, and managing ITS projects need a solid foundation not only in transportation engineering concepts and principles but also systems engineering, communications, and technology. This project developed a special topics course on the planning, design, and implementation of ITS projects for transportation management. This course is a graduate-level survey course in which students are provided with the basic knowledge and concepts needed to plan, design, and implement an ITS project that can be deployed in the field. Course topics include: <ul style="list-style-type: none"> <li>• an overview of ITS technologies and applications for advanced transportation management,</li> <li>• the application of system engineering concepts in the planning and design of advanced ITS projects,</li> <li>• techniques and strategies for managing and deploying ITS projects,</li> <li>• design and application of advanced telecommunication techniques for ITS deployments, and</li> <li>• techniques and tools for evaluating ITS project and technologies.</li> </ul>					
17. Key Word  Intelligent Transportation Systems, Systems, Systems Engineering, Communications, Surveillance Technologies			18. Distribution Statement  Public distribution		
19. Security Classif. (of this report) Unclassified		20. Security Classif. (of this page) Unclassified		21. No. of Pages 189	22. Price n/a



**Development of a Special Topics Course on  
Intelligent Transportation Systems  
for the  
Zachry Department of Civil Engineering of  
Texas A&M University**

**Kevin N. Balke, Ph.D., P.E.**  
Center Director, TransLink® Research Center  
Texas Transportation Institute

**Robert E. Brydia**  
Research Scientist, TransLink® Research Center  
Texas Transportation Institute

Texas Transportation Institute  
Texas A&M University System  
College Station, Texas 77843-3135

Final Report  
Project # 08-27-02

August 31, 2009

**Disclaimer**

The contents of this report reflect the views of the authors, who are responsible for the facts and accuracy of the information presented herein. This document is disseminated under the sponsorship of the Department of Transportation, University Transportation Centers Program in the interest of information exchange. The U.S. Government assumes no liability for the contents or use thereof.

**Acknowledgements**

Support for this research was provided by a grant from the U.S. Department of Transportation, University Transportation Centers Program to the University Transportation Center for Mobility (DTRT06-G-0044).

The authors gratefully acknowledge the leverage provided by the Zachry Department of Civil Engineering at Texas A&M University, College Station. The authors thank David V. Rosowsky, Ph.D., P.E., and Gene Hawkins, Ph.D., P.E., both from the Texas A&M Department of Civil Engineering, for their valuable participation in the project.

## Table of Contents

Purpose .....	1
Learning Objectives.....	1
Target Audience .....	2
Course Structure .....	2
Course Outline .....	2
Lecture Materials .....	4
Laboratory Exercises .....	4
Evaluation Materials .....	5
Refinement of Materials.....	5
Appendix A: Lecture Slides for Module 1. Overview of Intelligent Transportation Systems ...	7
Appendix B: Lecture Slides for Module 2. Systems and Systems Engineering .....	35
Appendix C: Lecture Slides for Module 3. Traffic Sensing Technologies .....	89
Appendix D: Lecture Slides for Module 4. Communications Systems for ITS Applications..	115
Appendix E: Lecture Slides for Module 5. Evaluating ITS Projects .....	165



# **Development of a Special Topics Course on Intelligent Transportation Systems for the Zachry Department of Civil Engineering of Texas A&M University**

## **Purpose**

With Intelligent Transportation Systems (ITS), engineers and system integrators blend emerging detection/surveillance, communications, and computer technologies, and transportation management and control concepts to improve the safety and mobility of the surface transportation system. Individuals responsible for developing, deploying, and managing ITS projects need a solid foundation not only in transportation engineering concepts and principles, but also systems engineering, communications, and technology. The purpose of this project was to develop and teach, at least once, a special topics course on the planning, design, and implementation of ITS projects for transportation management. This course was envisioned to be a graduate-level survey course in which students would be provided with the basic knowledge and concepts needed to plan, design, and implement an ITS project that could be deployed in the field. The topics covered in the proposed course include the following:

- an overview of ITS technologies and applications for advanced transportation management,
- the application of system engineering concepts in the planning and design of advanced ITS projects,
- techniques and strategies for managing and deploying ITS projects,
- designs and application of advanced telecommunication techniques for ITS deployments, and
- techniques and tools for evaluating ITS project and technologies.

## **Learning Objectives**

The learning objectives used in the development of this project were as follows.

At the conclusion of this course the student should be able to do the following:

- Highlight and discuss the fundamental characteristics of ITS and its importance as a traffic management tool in addressing today's mobility and safety problems.
- Apply basic system engineering principles and concepts to develop an understanding of operations and system and functional requirements for an ITS implementation.
- Using the results of the system engineering process, conduct a high-level alternatives analysis of different communication systems and alternatives.



- Demonstrate a basic understanding of the traffic detection and surveillance technologies.
- Demonstrate a basic understanding of the principles, procedures, and tools for evaluating ITS projects.

### **Target Audience**

The course was developed as a graduate-level course intended for students who are pursuing an advanced degree in civil engineering with a concentration in transportation engineering. The following prerequisites are needed by students to successfully complete this course:

- a bachelor's degree in civil engineering or equivalent area of study,
- a fundamental understanding of traffic flow concepts and objectives, and
- a fundamental knowledge of traffic control concepts and systems.

The course was designed to accommodate 10-15 students per class and laboratory period.

### **Course Structure**

The course was structured as a 3-credit hour course, with 2 hours devoted to instructor-led lecture and a 3-hour laboratory period per week. The laboratory periods were intended to provide the student with opportunities to apply concepts and materials presented in the lectures to real-world problems in the hopes of further strengthening the learning objectives in the students. The laboratories themselves consisted of both problem-solving exercises as well as field visits to local testbeds where students could see a real ITS project in operation.

### **Course Outline**

The basic outline developed for the course is as follows:

#### Week 1

Basic Introduction – What is ITS? History of ITS, current Federal Highway Administration (FHWA) initiatives, applications overview (Lab: Tour of TransLink center)

#### Week 2

National ITS Architecture, logical architecture, physical architecture, market packages, equipment packages, local and regional architectures (Lab: Turbo Architecture)

#### Week 3

Systems Engineering – Introduction to systems engineering concepts, concept exploration and benefits assessment (feasibility study), development and use of concepts of operations, Unified Modeling Language (UML) use case diagrams (Lab: Development of concept of operations)

#### Week 4

Systems Engineering (cont.) – Functional and system requirements, project level architecture (physical and logical), UML activity diagrams (Lab: Preparation of functional requirements)

#### Week 5

Systems Engineering (cont.) – Deployment/integration plan, planning of operations and maintenance, 1st partial exam

#### Week 6

Deployment of ITS Project – Procurement of ITS systems and technologies, managing ITS contracts, system testing and verification (Lab: Development of system testing and verification plan)

#### Week 7

Traffic Sensors and Detection Technologies – Embedded traffic sensors, non-intrusive detection systems, evaluation of sensor technologies (Lab: Site visit to local sensor testbed and field deployments)

#### Week 8

Traffic Sensors and Detection Technologies (cont.) – Embedded traffic sensors, non-intrusive detection systems, evaluation of sensor technologies (Lab: Conduct alternatives analysis for detection strategies)

#### Week 9

Communications – Basic concepts and terminology, wireline communications technologies, wireless communications technologies, standards and protocols (Lab: Design of communications plan)

#### Week 10

Communications (cont.) – Basic concepts and terminology, wireline communications technologies, wireless communications technologies, NTCIP standards, 2nd partial exam

#### Week 11

Evaluation Strategies and Tools – Evaluation concepts, use of sketch-planning, mesoscopic, and microscopic simulation models in evaluating ITS systems (Lab: IDAS/Dynasmart application/demonstration)

#### Week 12

Evaluation Strategies and Tools – Microscopic simulation concepts, microscopic simulation models (Lab: Corsim/VISSIM application/demonstration)

### Week 13

Presentation of semester project (Lab: Conduct site visit to Houston TranStar)

### Week 14

Summary and final review of course material, final exam

## **Lecture Materials**

A series of lecture materials were developed to provide students with the basic knowledge they needed to achieve the learning objectives. The lecture materials were grouped into five modules:

- Module 1: Overview of Intelligent Transportation Systems
- Module 2: Systems and Systems Engineering
- Module 3: Traffic Sensing Technologies
- Module 4: Communications Systems for ITS Applications
- Module 5: Evaluating ITS Projects

A copy of the lecture materials are contained in the appendices to this report.

## **Laboratory Exercises**

Laboratory exercises were designed to provide students with opportunities to solidify and apply the concepts, principles, and tools discussed in lectures to real-world situations. Ideally, students would be provided a scenario/problem to address during the first week of the course. Students would then use the same scenario throughout the semester and work on different aspects of planning and designing an ITS project to address the scenario. For the first class session, the plan was to use the scenario for developing a system to detect wrong-way vehicles and disseminate this information to travelers on a stretch of semi-rural roadway in College Station. Students would then be asked to develop concepts of operations, prepare functional requirements, develop test plans, etc., for ITS solutions that they developed for this scenario. At the end of the course, students would present their system designs to their classmates and the instructor for review, comment, and evaluation. Students would need to be able to respond to comments and questions and defend their design and selected approach.

A list of the planned laboratory exercises is shown below:

- Tour TransLink® Research Center laboratory
- Use Turbo Architecture to develop high-level architecture
- Develop concept of operation document
- Prepare functional requirements
- Develop system testing and verification plan
- Conduct site visit to local sensor testbed and field deployments

- Conduct alternatives analysis for detection strategies
- Design communications plan
- Conduct IDAS evaluation of proposed system
- Apply/demonstrate Corsim/VISSIM
- Conduct site visit to Houston TranStar (optional)

## **Evaluation Materials**

The suggested grading policy for the course is as follows:

Homework/Lab Assignments	10%
Exam #1	20%
Exam #2	20%
Semester Project	20%
Final Exam	25%
Class Participation	5%

Passing grades for graduate students are A, B, C and S.

As discussed above, 20 percent of the student’s final grade was to come from a semester project. The class would be divided into groups, depending on the number of students in the class. Each group would prepare an ITS application using the concepts and techniques discussed in class. The other members of the student’s group would be asked to assess the relative contribution of the student to the group effort. An individual’s grade would then be adjusted based upon the amount of contribution the individual made to the group effort. For example, if a group scored a 90 on its project and the members of the group felt that a particular student’s contributed only at 75 percent to the total group effort, then that student would receive a grade of 75 percent of the total project score, for an individual score of 67.5. Therefore, it would be important for the student to participate fully in all of the group’s activities. Specific information and instructions regarding this project would be provided when the project was assigned.

## **Refinement of Materials**

The scope of work for this project included developing the course material and teaching the course at least once before refining the material; however, teaching did not occur during the timeframe of the project. The course was offered twice – in the Fall 2008 and Spring 2009 semesters – but failed to receive the minimum number of registration to make the course viable according to University policies. Therefore, the prepared lecture and laboratory materials are presented here prior to refinement based on instructor and student feedback.



## **Appendix A: Lecture Slides for Module 1. Overview of Intelligent Transportation Systems**



# Overview of Intelligent Transportation Systems

Module 1

## What is ITS?

- Use of a **broad range** of wireless and wireline **communications-based** information and **electronics technologies** that, when **integrated** into the transportation system's **infrastructure**, and in **vehicles** themselves, relieve **congestion**, improve **safety** and enhance American **productivity**.



## Intelligent Infrastructure

- Arterial Management
- Freeway Management
- Transit Management
- Incident Management
- Emergency Management
- Electronic Payment
- Traveler Information
- Crash Prevention and Safety
- Roadway Operations and Maintenance
- Road Weather Management
- Commercial Vehicle Operations
- Intermodal Freight

## Freeway Management

Sensor and Surveillance Systems



Freeway Management Center



Managed Lane Systems



Ramp Control Systems



Information Dissemination Systems

## Transit Management Systems

- Advanced Communication Systems (ACS)
- Automatic Vehicle Location System (AVL)
- In-Vehicle Diagnostic System (IVD)
- Transit Operations Software (TOS)
- Computer-Aided Dispatch Systems
- Automatic Passenger Counters (APC)



## Electronic Toll Collection



# Intelligent Vehicles

- Collision Avoidance Systems
- Collision Notification Systems
- Driver Assistance System

## Example of Intelligent Vehicle Systems



Adaptive Headlights



Rear Collision Warning



Information Displays



Forward Collision Warning



Lane Departure



Obstacle Detection

## Brief History of ITS

- *Intermodal Surface Transportation Efficiency Act of 1991 (ISTEA)*
  - Formally Federal program
  - Facilitate deployment of technology to enhance efficiency, safety, and convenience to improve access, save lives and time, and increase productivity
- *Safe, Accountable, Flexible, Efficient Transportation Equity Act (SAFETEA-LU)*
  - Ended ITS Deployment Program in 2005
  - Continued ITS research funding through 2009
  - Authorized ITS eligibility for regular Federal-aid highway funds

Overview of Intelligent Transportation Systems

## **NATIONAL ITS ARCHITECTURE**

## What is an “Architecture”?

- Framework within which a system can be built
- Defines
  - Functions
  - Physical entities or subsystems
  - Information and data flows
- Describes
  - “What a system must do”
  - NOT how it will be done → independent of technology

## What is the “National ITS Architecture”?

- Common framework within which a system can be built
- Defines
  - Functions
  - Physical entities or subsystems
  - Information and data flows
- Describes
  - “What a system must do”
  - NOT how it will be done → independent of technology

## National ITS Architecture: Key Concepts

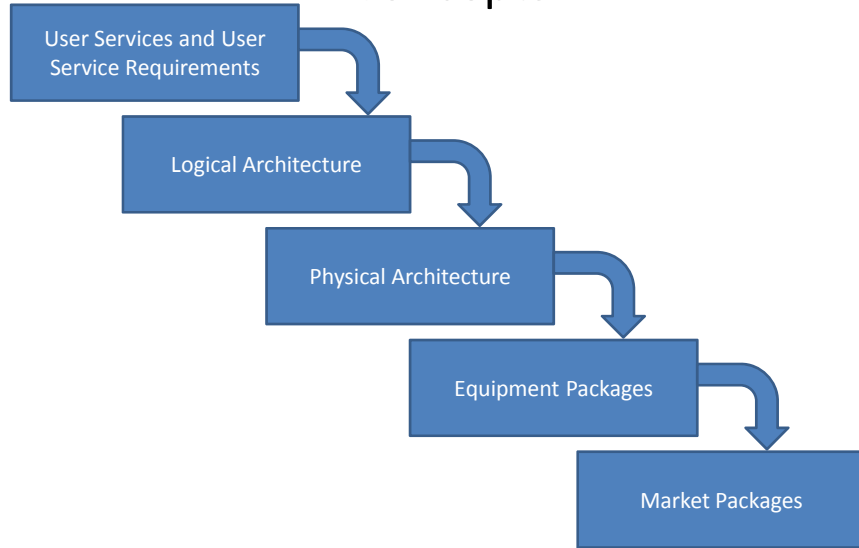

## User Services and User Service Requirements

- 33 user services grouped into 8 user service bundles
  - Travel and Traffic Management
  - Public Transportation Management
  - Electronic Payment
  - Commercial Vehicle Operations
  - Emergency Management
  - Advanced Vehicle Safety Systems
  - Information Management
  - Maintenance and Construction Management

## User Services Bundles/User Services

### **Travel and Traffic Management**

- Pre-Trip Travel Information
- En-route Driver Information
- Route Guidance
- Ride Matching and Reservation
- Traveler Services Information
- Traffic Control
- Incident Management
- Travel Demand Management
- Emissions Testing and Mitigation
- Highway Rail Intersection

### **Public Transportation Management**

- Public Transportation Management
- En-route Transit Information
- Personalized Public Transit
- Public Travel Security

## User Services Bundles/User Services

### **Electronic Payment**

- Electronic Payment Services

### **Commercial Vehicle Operations**

- Commercial Vehicle Electronic Clearance
- Automated Roadside Safety Inspection
- On-board Safety and Security Monitoring
- Commercial Vehicle Administrative Processes
- Hazardous Materials Security and Incident Response
- Freight Mobility

## User Services Bundles/User Services

### **Emergency Management**

- Emergency Notification and Personal Security
- Emergency Vehicle Management
- Disaster Response and Evacuation

### **Advanced Vehicle Safety Systems**

- Longitudinal Collision Avoidance
- Lateral Collision Avoidance
- Intersection Collision Avoidance
- Vision Enhancement for Crash Avoidance
- Safety Readiness
- Pre-crash Restraint Deployment
- Automated Vehicle Operations

## User Services Bundles/User Services

### **Information Management**

- Archived Data

### **Maintenance and Construction Management**

- Maintenance and Construction Operations



## User Service Requirements

- A specific functional requirement statement of what must be done to support an ITS user service.
- Example: Traffic Control
  - ITS shall include a Traffic Control (TC) function. Traffic Control provides the capability to efficiently manage the movement of traffic on streets and highways. Four functions are provided, which are (1) Traffic Flow Optimization, (2) Traffic Surveillance, (3) Control, and (4) Information. This will also include control of network signal systems with eventual integration of freeway control.

## Logical Architecture

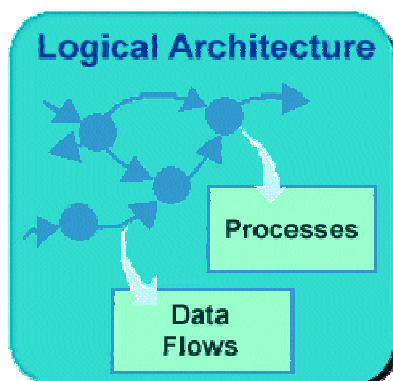

- Processes – functions or activities performed
- Data Flows – pipelines along which information of known composition is passed

## Data Flow Diagram

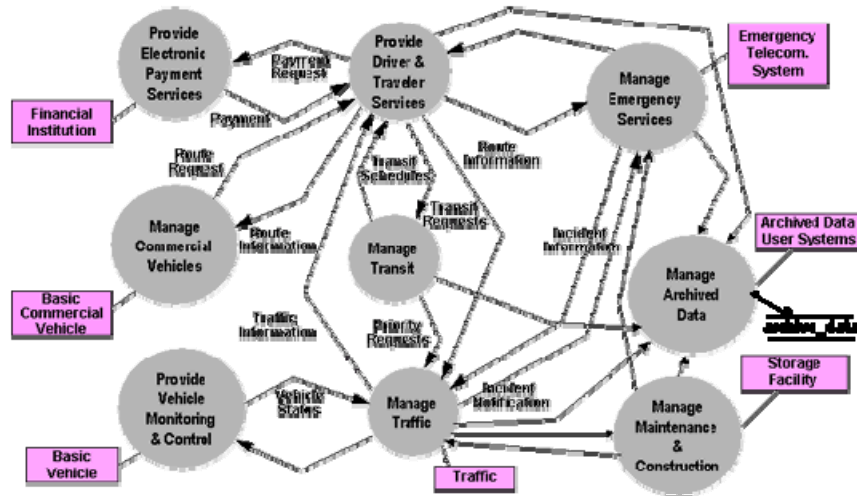

## Physical View of National ITS Architecture

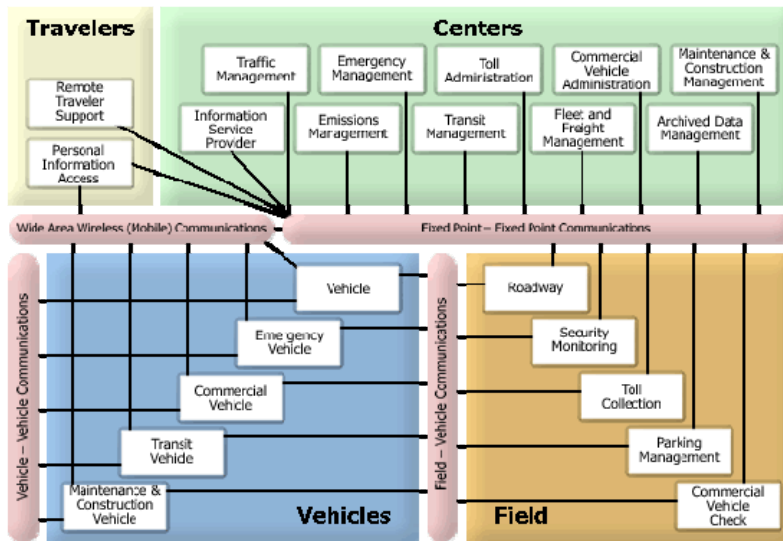

# Systems and Subsystems

<b>Centers</b>	<ul style="list-style-type: none"> <li>• <a href="#">Archived Data Management Subsystem</a> (ADMS)</li> <li>• <a href="#">Commercial Vehicle Administration</a> (CVAS)</li> <li>• <a href="#">Emergency Management</a> (EM)</li> <li>• <a href="#">Emissions Management</a> (EMMS)</li> <li>• <a href="#">Fleet and Freight Management</a> (FMS)</li> <li>• <a href="#">Information Service Provider</a> (ISP)</li> <li>• <a href="#">Maintenance and Construction Management</a> (MCMS)</li> <li>• <a href="#">Toll Administration</a> (TAS)</li> <li>• <a href="#">Traffic Management</a> (TMS)</li> <li>• <a href="#">Transit Management</a> (TRMS)</li> </ul>
<b>Field</b>	<ul style="list-style-type: none"> <li>• <a href="#">Commercial Vehicle Check</a> (CVCS)</li> <li>• <a href="#">Parking Management</a> (PMS)</li> <li>• <a href="#">Roadway Subsystem</a> (RS)</li> <li>• <a href="#">Security Monitoring Subsystem</a> (SMS)</li> <li>• <a href="#">Toll Collection</a> (TCS)</li> </ul>
<b>Travelers</b>	<ul style="list-style-type: none"> <li>• <a href="#">Personal Information Access</a> (PIAS)</li> <li>• <a href="#">Remote Traveler Support</a> (RTS)</li> </ul>
<b>Vehicles</b>	<ul style="list-style-type: none"> <li>• <a href="#">Commercial Vehicle Subsystem</a> (CVS)</li> <li>• <a href="#">Emergency Vehicle Subsystem</a> (EVS)</li> <li>• <a href="#">Maintenance and Construction Vehicle</a> (MCVS)</li> <li>• <a href="#">Transit Vehicle Subsystem</a> (TRVS)</li> <li>• <a href="#">Vehicle</a> (VS)</li> </ul>

## Terminators

- Define the boundaries of an architecture
- Represent the people, systems, and general environment that interface with ITS
- Example: Basic Commercial Vehicle Terminator

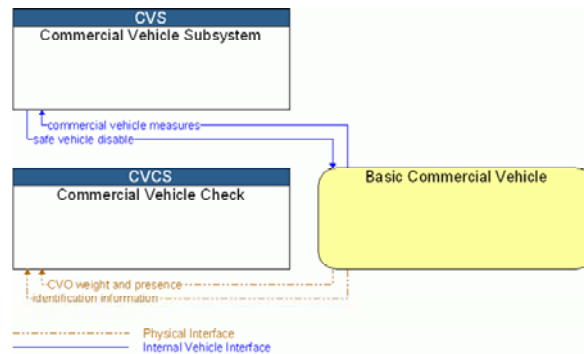

# Physical Architecture

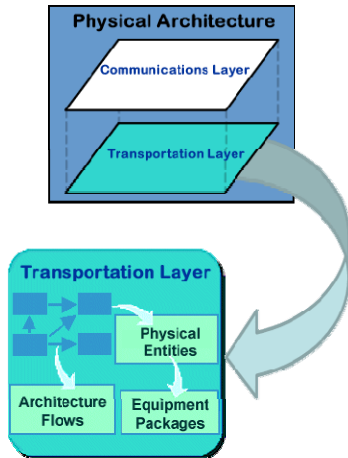

- Communications Layer
- Transportation Layer
  - Physical Entities – persons, places, and things
  - Architecture Flows – information that is exchanged between subsystems and terminators
  - Equipment Packages – grouping of similar processes of a particular subsystem into “implementable” packages

# Communications Layer



Fixed Point to Fixed Point



Fixed Point to Vehicle

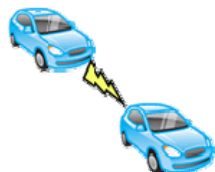

Vehicle to Vehicle



Wide Area Network (Mobile)

# Architecture Flows

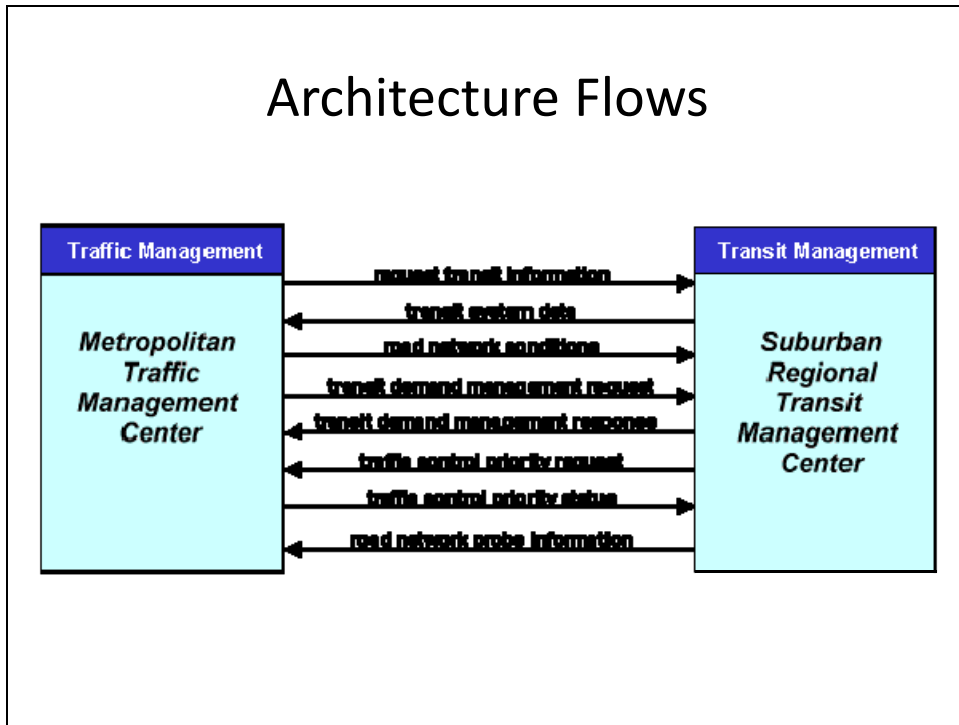

## TMC Traffic Management Decision Support (Equipment Packages\*)

[Functionality] [Inputs/Outputs]

This equipment package recommends courses of action to the traffic operator based on current and forecast road and traffic conditions. Traffic incidents, special events, maintenance activities and other events or conditions that impact capacity or demand are monitored. Historical data and models are used to compare the impact of potential courses of action and make recommendations to the operator. Decisions are supported through presentation of filtered and fused network-wide road and traffic conditions that identify network imbalances and recommended courses of action. The recommended actions may include predefined incident response plans, signal timing plan changes, DMS/HAR messages, and freeway control strategies including ramp metering, interchange control, and lane controls. Multimodal strategies may also be recommended that include suggested transit strategies and suggested route and mode choices for travelers. Once a course of action is selected, other equipment packages implement these actions within the traffic management center and coordinate the response with other centers in the region.

### Included In:

[Traffic Management](#)

Market Packages:

- [ATMS09-Traffic Decision Support and Demand Management](#)

### Functionality:

#### Functional Requirements:

1. The center shall provide center personnel with an integrated regional view of current and forecast road and traffic conditions including traffic incidents, special events, maintenance activities and other events or conditions that impact capacity or demand.
2. The center shall identify network imbalances and potential courses of action.
3. The center shall compare the impact of potential courses of action and make recommendations to the operator.
4. The recommended actions shall include predefined incident response plans, signal timing plan changes, DMS/HAR messages, and freeway control strategies including ramp metering, interchange control, and lane controls.
5. The recommended actions shall include multimodal strategies that include suggested transit strategies and suggested route and mode choices for travelers.
6. The center shall provide an interface to center personnel to input control parameters for the decision support process and receive recommended actions and supporting information presentation.

Pspects:

- [1.3.4.2-Provide Traffic Operations Personnel Incident Data Interface](#)
- [1.3.5-Manage Incident Response Planning](#)

### Inputs/Outputs (Included Architecture Flows)

Source	Architecture Flow	Destination
<a href="#">Traffic Management</a>	<a href="#">traffic operator data</a>	<a href="#">Traffic Operations Personnel</a>
<a href="#">Traffic Operations Personnel</a>	<a href="#">traffic operator inputs</a>	<a href="#">Traffic Management</a>

**Standards** - This icon indicates that the associated architecture flow either has been or will be addressed by ITS Standards. Select the architecture flow for more information on relevant standards activities.

# Market Packages

- A collection of one or more **equipment packages** within the **subsystems** that are required to deliver a particular transportation service and the **architecture flows** that connect them. These three things identify the **physical architecture** that is required to implement the particular transportation service.

ATMS09 – Traffic Decision Support and Demand Management

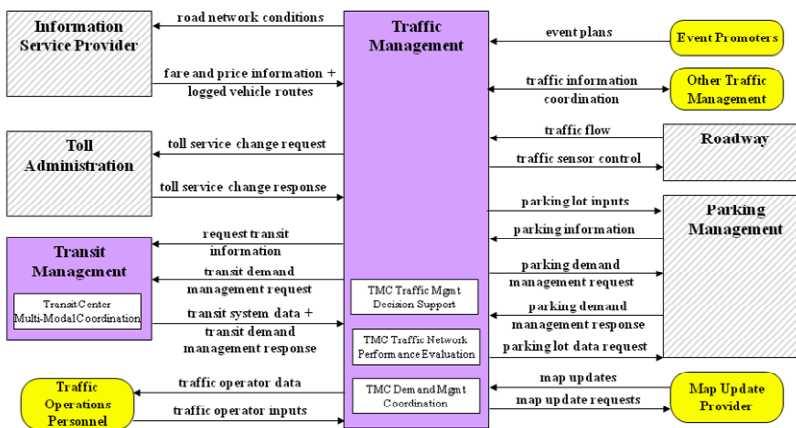

## Institutional Layer

- Includes the policies, funding incentives, working assignments and jurisdictional structure that support the technical layers of the architecture
- Basis for understanding who the stakeholders are and what role they play

## What is a “Stakeholder”?

STAKEHOLDER	EXAMPLES
Public Agencies	State /City Department of Transportation (DOT) Public Transportation Agencies Metropolitan Planning Organization (MPO) Emergency Services
Private Organizations	Private information service providers Manufacturers Special interest groups
Travelers	Commuter Transit riders Commercial vehicle operators (CVO)

## Example of a Market Package: Transit Vehicle Tracking

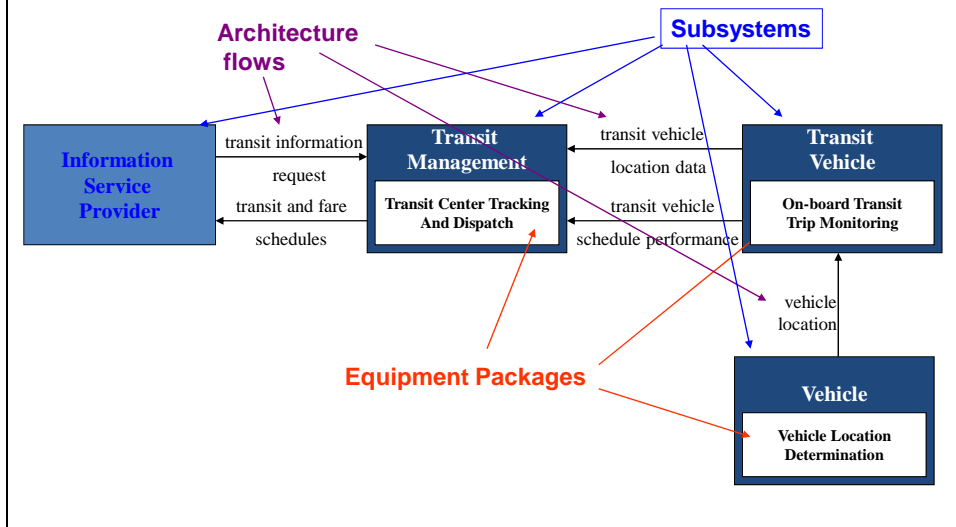

## ITS Standards

- Define how ITS systems products and components can interconnect, exchange information and interact to deliver services
- Cover the communications layers – how data is communicated between systems
- Interoperability: ability of systems to...
  - Provide information and services to other systems
  - Use exchange information and services to operate together effectively



<i>Standard Development Organizations (SDO) Home Page</i>	<i>Applicable Interfaces in the National ITS Architecture</i>	<i>ITS Standards Specific Sites</i>
<a href="#">AASHTO, ITE, NEMA</a>	Traffic Management Center to other Centers Traffic Management Center to Field Devices	<a href="#">National Transportation Communications for ITS Protocol(NTCIP)</a>
<a href="#">AASHTO, ITE</a>	Traffic Management Center to other Centers	<a href="#">Traffic Management Data Dictionary (TMDD) and Message Sets</a>
<a href="#">ANSI</a>	Commercial Vehicle Operations (CVO)-related system interfaces	<a href="#">Commercial Vehicle Information Systems and Networks (CVISN)</a>
<a href="#">ASTM</a>	Archived Data Management Center Interfaces	<a href="#">Archived Data</a>
<a href="#">ASTM, IEEE, SAE</a>	Vehicle to Vehicle; Field to Vehicle	<a href="#">Dedicated Short Range Communications (DSRC)</a>
<a href="#">IEEE</a>	Emergency Management Center to other Centers	<a href="#">Incident Management</a>
<a href="#">APTA</a>	Transit Center to other Centers and Transit Vehicles	<a href="#">Transit Communications Interface Profiles (TCIP)</a>
<a href="#">SAE</a>	Traveler Information (Information Service Provider interfaces) Location Referencing	Advanced Traveler Information Systems (ATIS)

## National Transportation Communications for ITS Protocol (NTCIP)

- family of standards that provides both the rules for communicating (called protocols) and the vocabulary (called objects)
- set of standards for the transportation industry
- reduce the need for reliance on specific equipment vendors and customized one-of-a-kind software
  - Data Dictionary Standards
  - Message Set Standards
  - Protocol Standards

## Laboratory Exercise

- Exploring the National ITS Architectures (<http://www.iteris.com/itsarch/index.htm>)

Overview of ITS

### **CURRENT FEDERAL INITIATIVES**

## Cooperative Intersection Collision Avoidance Systems

- Use both vehicle-based and infrastructure-based technologies to help drivers approaching an intersection understand the state of activities within that intersection



## Electronic Freight Management

- Improve speed, accuracy, and information transfer when freight is transferred from one mode of transportation to another



## Emergency Transportation Operations

- Improve the management of all forms of transportation emergencies through the application of ITS technologies by:
  - Providing effective traveler information during major disasters
  - Planning and managing major incidents involving evacuation
  - Getting ITS into operation quickly during a disaster
  - Using ITS to monitor travel conditions on alternate and evacuation routes



## Integrated Corridor Management Systems

- Uses ITS technologies to efficiently and proactively manage the movement of people and goods in major transportation corridors in large cities.



## Integrated Vehicle-Based Safety Systems

- Combines existing safety and collision avoidance systems into an integrated system that can warn drivers of imminent crashes
  - Rear-end Collision Avoidance
  - Road Departure Collision Avoidance
  - Lane Change/Merge Collision Avoidance



## Mobility Services for All Americans (MSAA)

- Improve transportation services and simplify access to employment, healthcare, education, and other community activities by means of the advanced technologies of ITS



## CLARUS: National Surface Transportation Weather Observing and Forecasting System

- Mitigate the effects of adverse weather on all surface transportation users and operators by providing timely and accurate weather, pavement, and water level information.



## Next Generation 9-1-1 (NG911)

- Enable the transmission of voice, data, or video from different types of communication devices to the Public Safety Answering Points (PSAPs) and onto emergency responder networks



## IntelliDrive<sup>SM</sup>

- Formerly Vehicle Infrastructure Integration (VII)
- Deploy advanced vehicle-vehicle and vehicle-infrastructure communications that could keep vehicles from leaving the road and enhance their safe movement through intersections



## IntelliDrive<sup>SM</sup> Levels

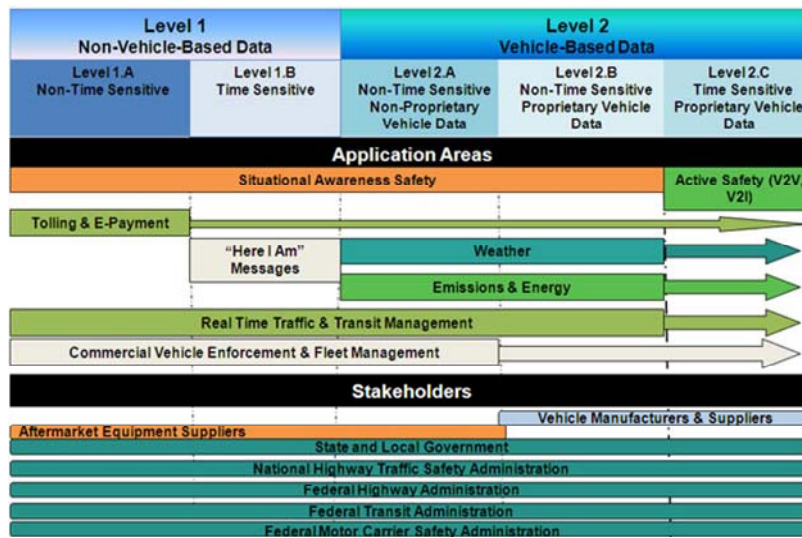

## Why is ITS Important to You?

- As Designers / Builders / Operators/ Maintainers
  - Continued emphasis at federal level
  - Better operating system delay need for expensive construction
  - Offer potential to improve safety
- As User
  - Improved decision-making at travel
  - Seamless transportation system

## Questions/Comments/Discussion

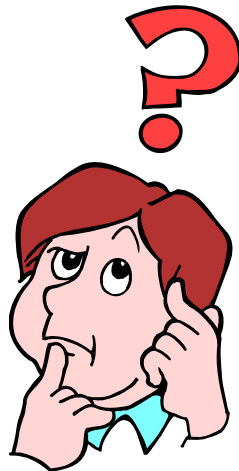





## **Appendix B: Lecture Slides for Module 2. Systems and Systems Engineering**



# Systems and Systems Engineering

## Module 2

### Reference Documents

- *Systems Engineering for Intelligent Transportation Systems*. USDOT, FHWA, January 2007.
- *Developing and Using a Concept of Operations in Transportation Management Systems*, August 2005.  
([http://tmcdfs.ops.fhwa.dot.gov/cfprojects/uploaded\\_files/conops\\_tms\\_handbook.pdf](http://tmcdfs.ops.fhwa.dot.gov/cfprojects/uploaded_files/conops_tms_handbook.pdf))
- *Developing Functional Requirements for ITS Projects*, April 2002.  
([http://www.itsdocs.fhwa.dot.gov/JPODOCS/REPTS\\_TE/13621.html](http://www.itsdocs.fhwa.dot.gov/JPODOCS/REPTS_TE/13621.html))
- M. Fowler and K. Scott *UML Distilled* 2<sup>nd</sup> Edition. Addison-Wesley, 2000.

## What is a “System”

- International Council on Systems Engineering (INCOSE) defines a system as:  
*A combinations of interacting elements organized to achieve one or more stated purposes*

## Examples of Systems in Transportation

- Using Bryan/College Station, can we list examples of transportation systems?

## Definition of Systems Engineering

- INCOSE defines systems engineering as:

*Systems Engineering is an interdisciplinary approach and means to enable the realization of successful systems. It focuses on defining customer needs and required functionality early in the development cycle, documenting requirements, then proceeding with design synthesis and system validation while considering the complete problem.*

*Systems Engineering integrates all the disciplines and specialty groups into a team effort forming a structural development process that proceeds from concept to production to operations. Systems Engineering considers both the business and the technical needs of all customers with the goal of providing a quality product that meets the user needs.*

## Why Do We Need Systems Engineering?

- 23 CFR 940.11 Project Implementation
  - All ITS projects funded with highway trust funds shall be based on a system engineering analysis.
  - The analysis should be on a scale commensurate with the project scope.
  - The systems engineering analysis shall include, at a minimum:
    - Identification of portions of the regional ITS architecture being implemented (or if a regional architecture does not exist, the applicable portions of the National ITS Architecture);
    - Identification of participating agencies roles and responsibilities;
    - Requirements definitions;
    - Analysis of alternative system configurations and technology options to meet requirements;
    - Procurement options;
    - Identification of applicable ITS standards and testing procedures; and
    - Procedures and resources necessary for operations and maintenance.

[http://www.ops.fhwa.dot.gov/its\\_arch\\_imp/policy.htm](http://www.ops.fhwa.dot.gov/its_arch_imp/policy.htm)

# Cone of Uncertainty

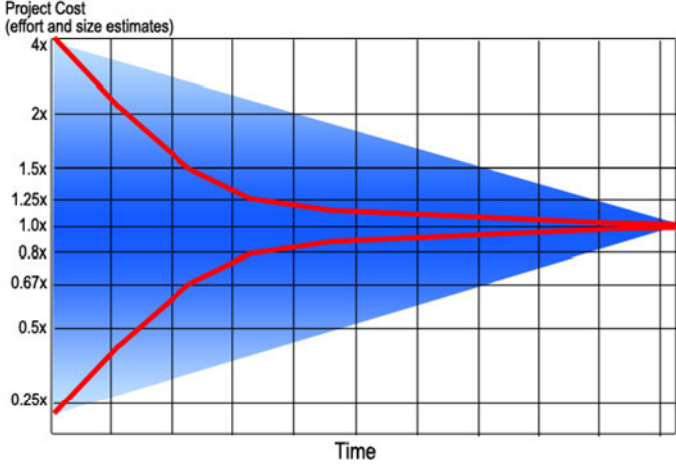

# Project Costs

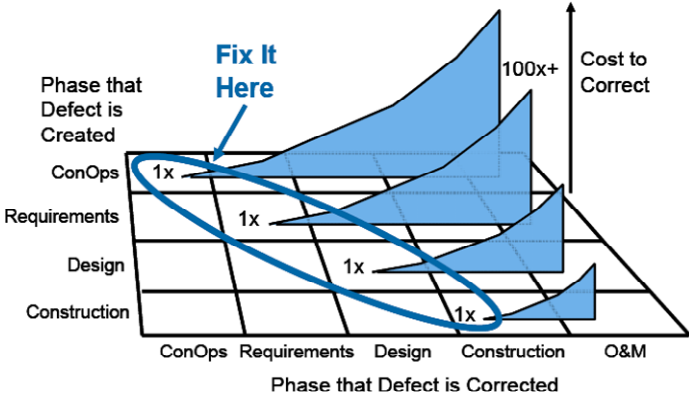
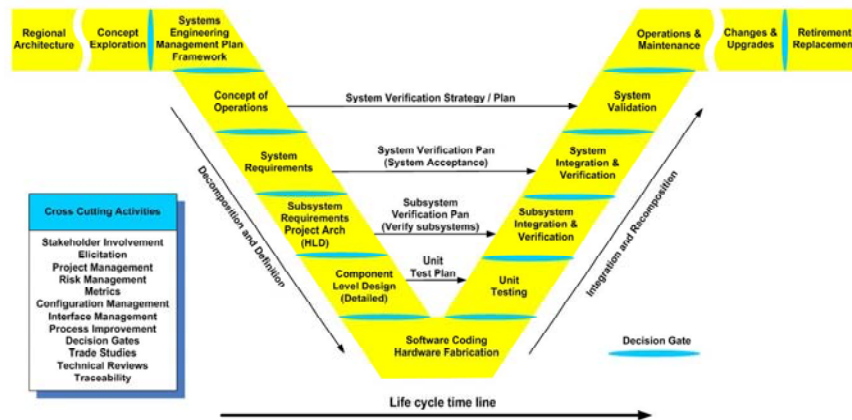

Figure 5: Late Changes Drive Project Costs  
 (Adapted from Steve McConnell, *Code Complete*)

# System Engineering Principles

- Begin with the end in mind
- Stakeholder involvement is critical
- Define the problem before implementing the solution
- Delay technology choices
- Maintain traceability

# Systems Engineering “V” Diagram





# Technical Documentation in the “V” System Engineering Process

- See Handout #1: Technical Documentation in the “V” System Engineering Process

## System Engineering Process Regional Architecture

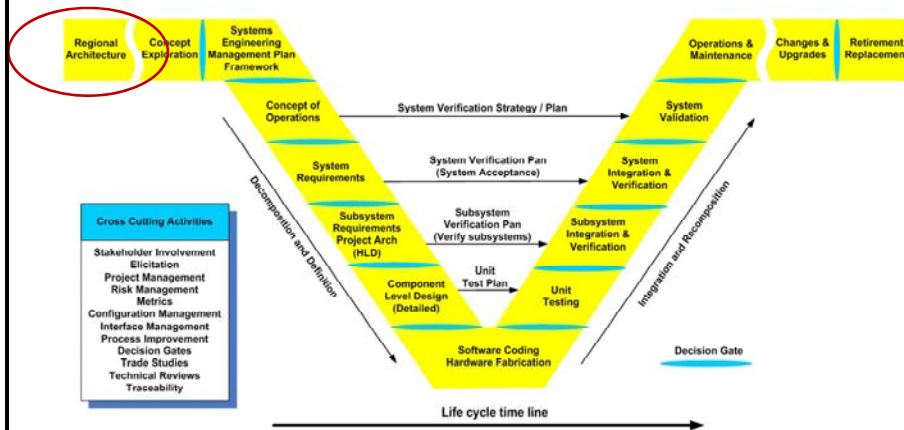

## Regional ITS Architecture

- Framework for institutional agreement and technical integration
- Starting point for defining basic scope of project
- Elements
  - Identification of stakeholders
  - Inventory of assets
  - Existing and future “market packages”
  - Identification of functions
  - Identification of system “interfaces”
  - Listing of appropriate standards

## Example of Regional Architecture

- [Brazos Valley Regional ITS Architecture](http://www.consystec.com/texas/web/brazos/brazosintro.htm)  
(link address: <http://www.consystec.com/texas/web/brazos/brazosintro.htm>)

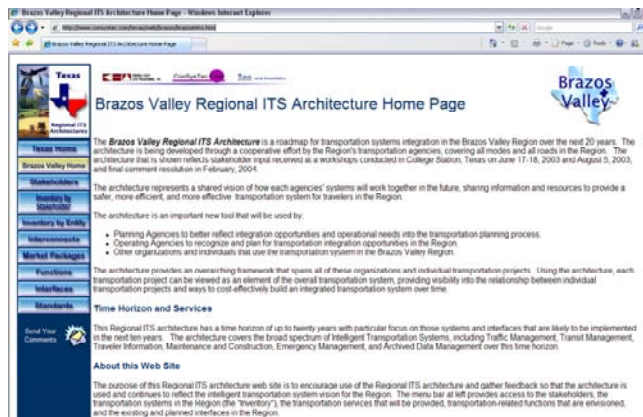

## Regional ITS Architecture: Key Activities

- Identify regional ITS architecture(s) that are relevant to the project
- Identify the portion of the regional ITS architecture that applies
- Verify consistency with the regional ITS architecture and identify any necessary changes to it

## Laboratory Exercise:

- Demo Turbo Architecture
- Develop Sample Architecture for Bryan/College Station Regional Transportation Operations

## System Engineering Process: Concept Exploration/Feasibility Study

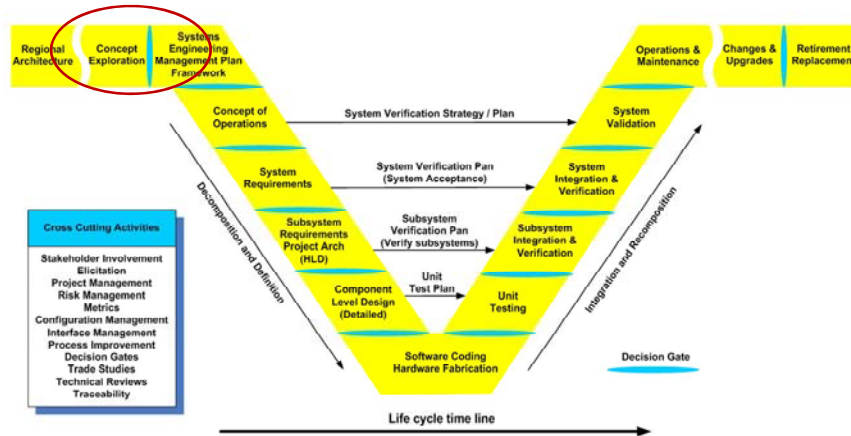

## Feasibility Study/Concept Evaluation

- Purpose: to determine whether project is viable
  - Technically
  - Economically
  - Operationally
- Consider multiple alternative concepts
- Alternatives considered at a high level, but with enough technical detail to ensure concept is implementable
- Establishes business case for investing in a project

## Concept Exploration Process

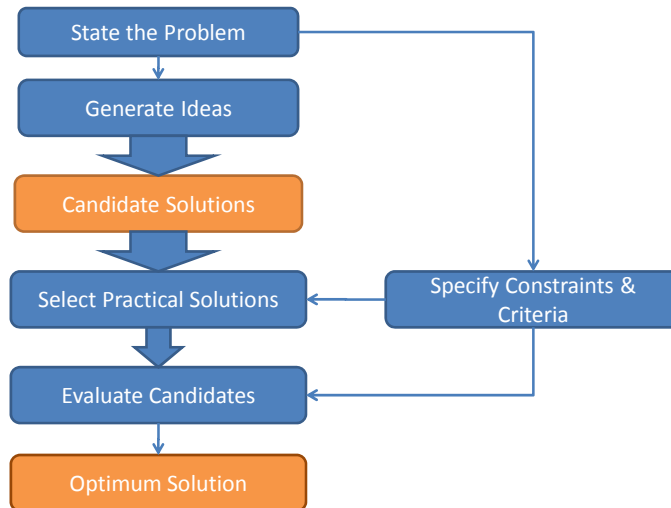

## Concept Exploration: Key Activities

- Define evaluation criteria
- Identify alternative concepts
- Evaluate alternatives
  - ITS Cost database
  - ITS Benefits database
  - ITS Deployment Analysis System (IDAS)
  - SCRITS (SCReening for ITS)
- Document Results

## Content of Feasibility Study Report

- Description of problem or opportunity
- Project objectives and evaluation criteria used
- Economic and risk assessment for each alternative and reasons for rejecting alternatives
- Summary description of selected alternative, including major system features and resources
- Economic analysis of funding sources, and life-cycle costs and benefits

## System Engineering Process: Concept of Operations

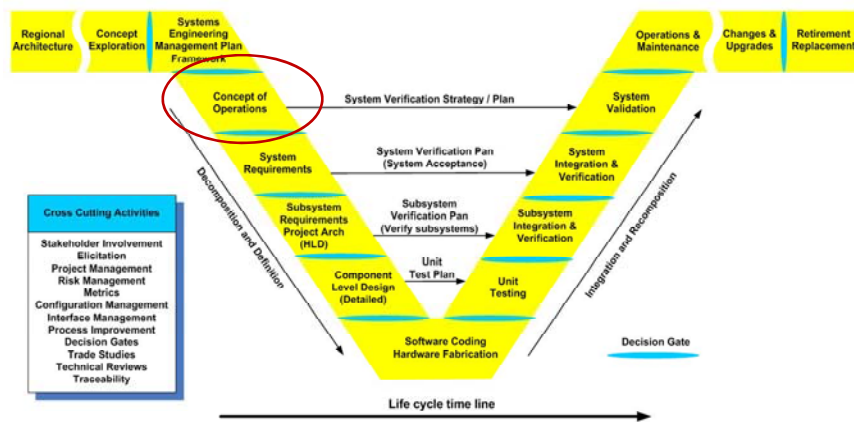

## Concept of Operations (ConOps)

- High-level identification of user needs and system capabilities
- Stakeholder agreement on roles and responsibilities
- Shared understanding by system owners, operators, maintainers, and developers on the WHO, WHAT, WHY, WHERE, and HOW of the system
- Key performance measures and basic implementation and validated plan

## Concept of Operations

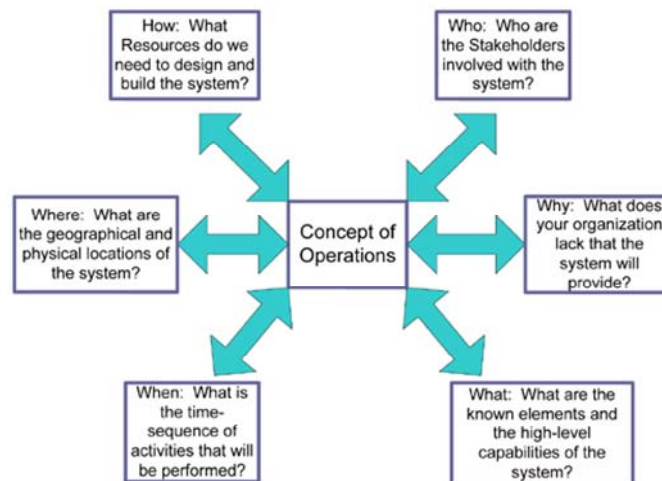

## Primary Questions to be Addressed in ConOps

- Who – Who are the stakeholders involved with the systems?
- What – What are the elements and the high-level capabilities of the systems?
- Where – What is the geographic and physical extent of the system?
- When – What is the sequence of activities that will be performed?
- Why – What is the problem or opportunity addressed by the system?
- How – How will the system be developed, operated, and maintained?

## ConOps: Key Activities

- Identify the stakeholders associated with system/project
- Define core group responsible for creating ConOps
- Develop an initial ConOps, review with broader group of stakeholders, and iterate
- Define stakeholder needs
- Create a System Validation Plan – approach to be used to validate the project delivery



# Industry Standards for ConOps

- ANSI/AIAA-G-043 Outline
  - Scope
  - Referenced Documents
  - User-Oriented Operational Description
  - Operational Needs
  - System Overview
  - Operational Environment
  - Support Environment
  - Operational Scenarios
- IEEE 1362 Outline
  - Scope
  - Referenced Documents
  - The Current System or Situation
  - Justification for and Nature of Changes
  - Concepts of the Proposed System
  - Operational Scenarios
  - Summary of Impacts
  - Analysis of the Proposed System

# Elements of a ConOps

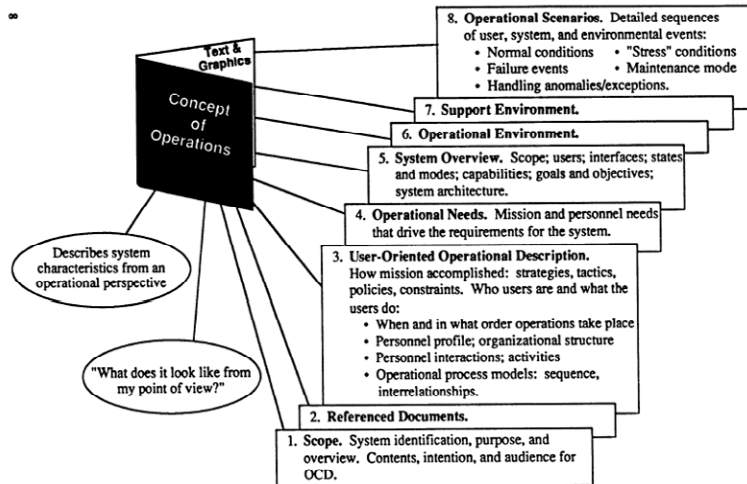

## Example: Roles and Responsibilities

L = Lead  
S = Support

Position	TMC Manager	TMC Operator	Maintenance Dispatch	TMS Engineer	IT	HQ Engineer	District Deputy of Operations	Program Manager	Director
Contacting Executives	L	S							
After incident briefing and analysis	L	S	S	S		S	S		S
Signal timing adjustments				L					
Field data detection				L					
Weather monitoring		L	S						
Road condition monitoring and communication	S	L	S						
Special event traffic monitoring	S	L	S						
Workzone lane closure logging	S	L	S						
Monitor workzone duration and congestion	S	S	S						
Incident response management	L	L	S						
News monitoring	S	L							

## Example: System Overview

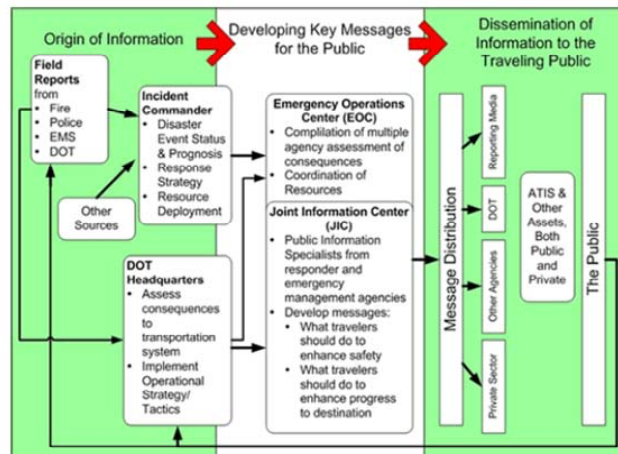

Figure 14: Example of System Overview Graphic (from *Communicating with the Public Using ATIS During Disasters Concept of Operations*)

## Example: Operational Scenario Description

Marcel, a StarTran bus operator, usually begins his work shift with administrative activities. After receiving supervisory direction, he boards the bus and prepares the AVL system. He begins by logging into the system.

The system then prompts Marcel for the route to be followed. He enters the planned route number, and the AVL system retrieves the appropriate route and schedule information from the AVL system server. The bus' AVL system then asks Marcel to verify the appropriate route and schedule information were properly retrieved.

Once he provides verification, the bus' head sign is automatically updated to reflect the appropriate route information. The fare payment schedule is automatically adjusted to reflect the verified route, modified as necessary by the system clock to reflect any applicable time-differential rates.

The system then loads the appropriate bus stop announcements for the chosen route. These prerecorded announcements are consistent regardless whether Marcel or another bus operator is driving the route, and have been verified as ADA compliant. These announcements are then broadcast at the appropriate bus stop throughout the route.

## Lab Activity

- Development of Concept of Operations for Regional Incident Management Responses for Bryan/College Station Mobility Initiative

## System Engineering Process: System Requirements

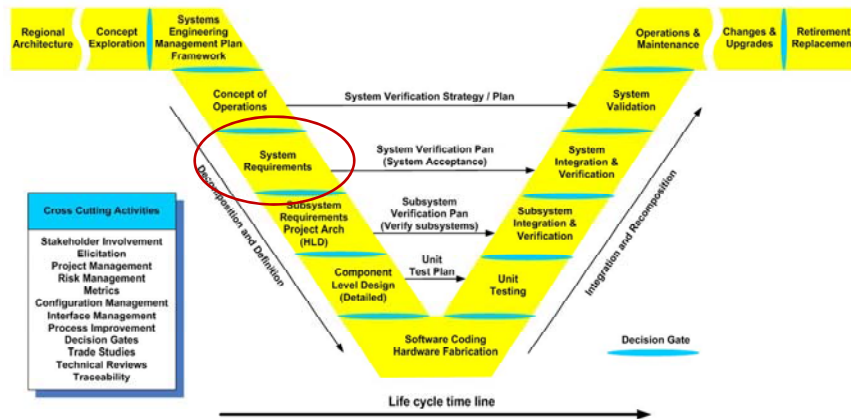

## System Requirements

- One of the most important (and often most difficult) steps in the process
- EIA-632 defines requirement as “something that governs what, how well, and under what conditions a product will achieve a given purpose”
- Functional requirements specify **WHAT, NOT HOW** system will accomplish its functions

## Requirement Process

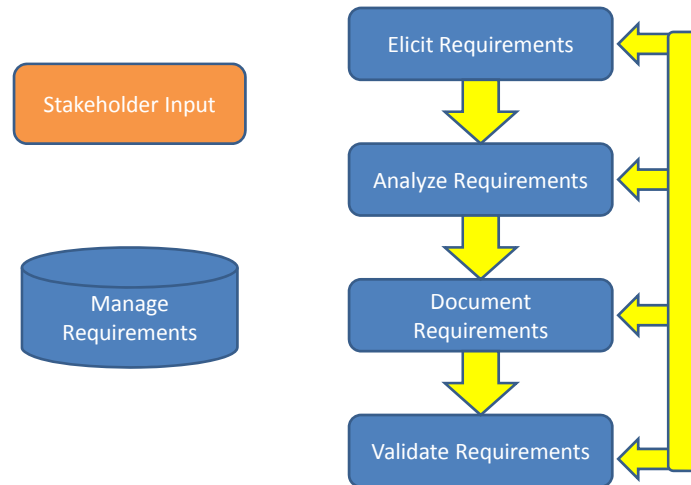

## Elicit Requirements

- Elicit – draw forth or evoke a response
- Critical to not only involve right organization, but right **person** within organization
- Techniques
  - Interviews
  - Scenarios
  - Prototypes
  - Facilitated meetings
  - Surveys
  - Observations

## The “Five Whys” Technique

### Stakeholder

- I need irrigation channels on my keyboard.
- I occasionally spill coffee on my keyboard.
- I need to have three or four manuals open to operate the system and the coffee just gets knocked over.

### System Engineer

- Why?
- Why?
- Why do you need to have three or four manuals open?

## Food for Thought

- Look beyond operational requirements and cover complete life cycle
  - System development
  - Deployment
  - Training
  - Transition
  - Operations and maintenance
  - Upgrades
  - Retirement
  - Security and safety

## Writing System/Functional Requirements

- Verb / Noun Description
- User Requirement → “monitor road weather conditions”
- Functional/Operational Requirements
  - Shall detect ice
  - Shall monitor wind speed
  - Shall monitor pavement temperature
- Performance Requirements → define the different kinds of ice conditions and range of wind speeds

## Analyzing Requirements

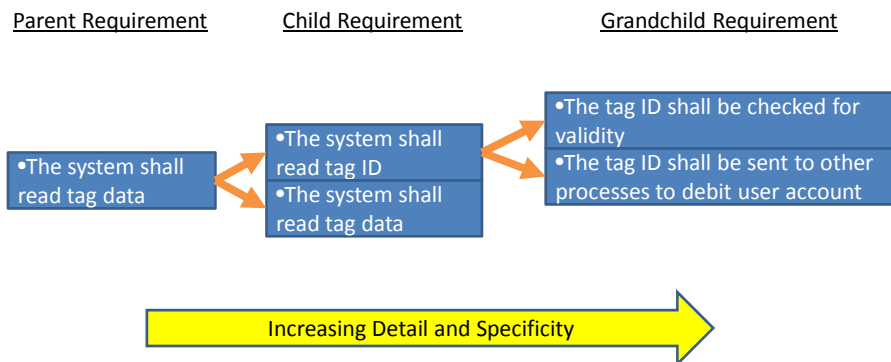

## Documenting Requirements

- Attributes of requirements
  - Requirement number
  - Source
  - Author
  - Creation date
  - Change history
  - Verification method
  - Priority
  - Status

## Traceability Matrix

- Example of Traceability Matrix



## Qualities of a Good Requirement

- **Necessary** – Does it relate to stakeholder need
- **Clear** – Is it ambiguous? Are there any other interpretations?
- **Complete** – If you implement all requirements, will need be met?
- **Correct** – If a child requirement is in conflict with parent, then either parent or child is incorrect
- **Feasible** – Can it be implemented? -- reality check
- **Verifiable** – Does requirement have a verification method? Is the requirement really stated in a way that is verifiable?

## Output of System Requirements

- System boundary with interfacing systems clearly identified.
- General system description, including capabilities, modes, and users, as applicable
- External interface requirements for interfacing systems and people
- Functional requirements and associated performance requirements
- Environmental requirements
- Life-cycle process requirements
- Reliability and availability
- Expandability
- Staffing, human factors, safety and security requirements
- Physical constraints

## Example: Oregon Department of Transportation (ODOT) TripCheck User Requirements (Excerpt)

REQ ID	ODOT PRIORITY	REQUIREMENT	AUDIENCE SEGMENTS					
			C	ICT	TT	ADA	CT	ALL
RR001	2	The system should allow the user to enter a multi-point route using a combination of the criteria specified in MP004c-f and h.	X	X	X	X		
RR001f	1	The system shall allow the user to select destination points by clicking on the map.	X	X	X	X		
		The system shall allow the user to specify the following when determining road routes (note: this functionality is for trip planning.):						
RR002a	2	- starting date AND/OR ending date if only one date is specified, the system calculates the other.			X	X		
RR002b	2	- starting time/ending time if only one time is specified, the system calculates the other.			X	X		
RR002c	2	- month of travel (instead of start/end)			X	X		
RR002d	4	- quickest route (by time)						X
RR002e	1	- shortest route (by miles)	X	X	X	X		
RR002f	2	- most scenic route (based on scenic byways within a user-specified mile radius of the direct (shortest) route)			X	X		
RR002g	3	- routes most recommended by others			X	X		

## Example: Maryland's Coordinated Highway Action Response Team (CHART) System Requirements (Excerpt)

<b>3.1.3 Equipment Inventory</b>
<i>The equipment inventory is a list of SHA equipment used in connection with CHART response to incidents. The system provides functions to maintain the inventory, equipment status, and to generate alerts for delinquent equipment.</i>
3.1.3.1 The system shall provide the capability to maintain the equipment inventory.
3.1.3.1.1 The system shall support the addition of new equipment entries to the inventory.
3.1.3.1.2 The system shall support the modification of existing equipment inventory entries.
3.1.3.1.3 The system shall support the deletion of equipment inventory entries.
3.1.3.1.4 The system shall support the allocation of equipment to events.
<b>3.1.4 Report Generation</b>
<i>This section lists requirements for the generation of reports from the CHART system and archive data.</i>
3.1.4.1 The system shall provide the capability to generate reports from online and archived data.
3.1.4.2 The system shall support the generation of operational reports.
3.1.4.2.1 The system shall support the generation of a Center Situation report.
3.1.4.2.2 The system shall support the generation of a Disable Vehicle event report.
3.1.4.2.3 The system shall support the generation of an Incident event report.
3.1.4.2.4 The system shall support the generation of traffic volume reports.

Further Example:

[http://www.chart.state.md.us/downloads/readingroom/chart\\_ii\\_documents/CHART\\_R3B3\\_Detailed\\_Design.pdf](http://www.chart.state.md.us/downloads/readingroom/chart_ii_documents/CHART_R3B3_Detailed_Design.pdf)

# Laboratory Exercise

- Develop system requirements for traffic signal controller

## System Engineering Process: System Design

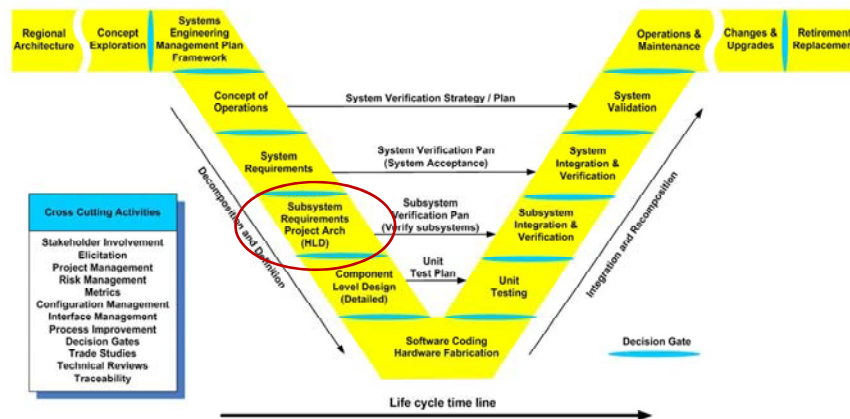

## System Design

- High-level design
  - Also referred to as *architectural design*
  - Defines overall “structure” of design
  - IEEE 610 – “the process of defining the collection of hardware and software components and their interfaces to establish the framework for the development of a computer system.”

## System Design

- Detailed Design
  - Complete specification of the software, hardware, and communications components
    - Software specifications – enough detail to allow developers to write code for individual modules
    - Hardware specifications – enough detail to allow hardware to be fabricated or purchased.

## High-Level Design – Key Activities

- Evaluate “off-the-shelf” components
  - Conventional wisdom – avoid “custom solutions” when possible
  - Advantage:
    - permits interoperability and interconnection
    - “bugs” generally worked out
  - Disadvantage: technology changes rapidly
  - Use recognized standards

## High-Level Design: Key Activities

- Develop and evaluate high-level design alternatives

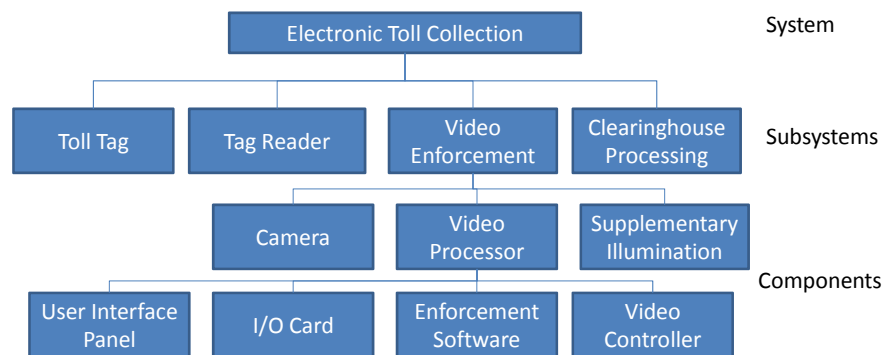

## Selection Criteria for Comparing High-level Design Alternatives

- Consistency with existing physical and institutional boundaries
- Ease of development, integration, and upgrading
- Management visibility and oversight requirements
- Remember: KISS principle (KeeP It Simple, Stupid)

## System Engineering Process: Detailed Design

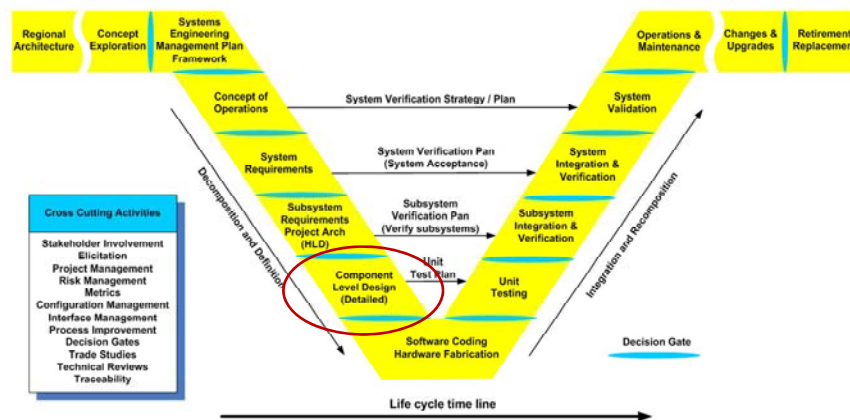

## Detailed Design

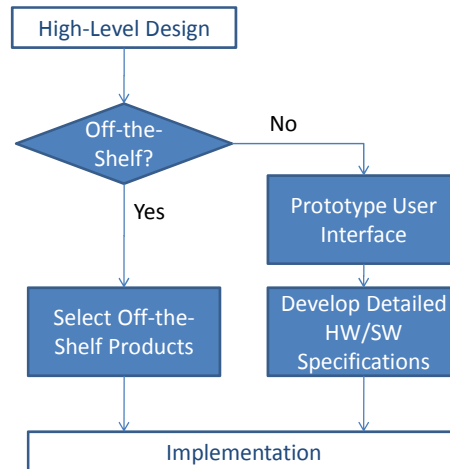

## Prototyping

- Quick, easy-to-build approximation of system
- Can be used for any part of system, but most often used with user interface design
- Helps user and developer “visualize” how system would work without detecting significant resources
- Expect multiple iterations

# System Engineering Process: Implementation

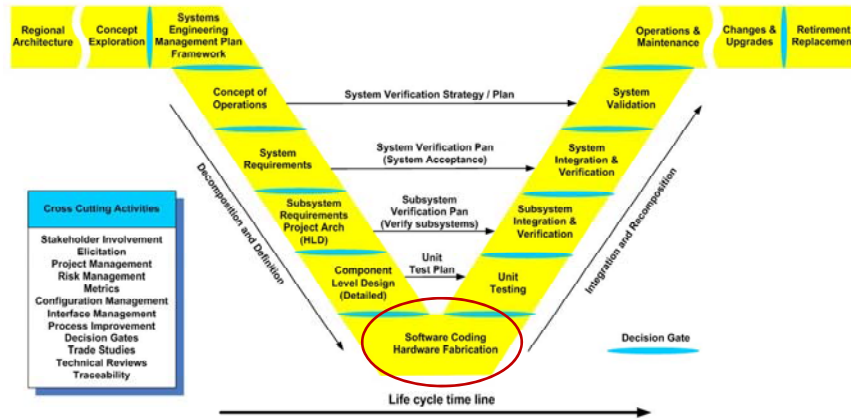

## What is UML?

- UML = Unified Modeling Language
- Communicates
  - Requirements
  - Architecture
  - Implementation
  - Deployment
  - States
- System described in terms of object
  - The actions that objects take
  - The relationships between objectives
  - The deployment of objects
  - The way the states of objects change in response to external events



## What is an Object?

- Objects are “Things”
- Example
  - Students in the classroom
  - Instructor
  - Computer
  - Powerpoint presentation

## Use Case Scenarios

- Scenarios → sequence of steps describing an interaction between a user and system
- Example: Web-based on-line store

*“The customer browses the catalog and adds desired items to the shopping basket. When the customer wishes to pay, the customer describes the shipping and credit card information and confirms the sale. The system checks the authorization on the credit card and confirms the sale both immediately and with a follow-up email.”*

- Source: M. Fowler and K. Scott *UML Distilled* 2<sup>nd</sup> Edition

## Use Case Scenario (continued)

- Use Case → set of scenarios tied together by a common user goal
- Example: Buy a Product
  1. Customer browses through catalog and selects items to buy
  2. Customer goes to check out
  3. Customer fills in shipping information (address; next-day or 3-day delivery)
  4. System presents full pricing information, including shipping
  5. Customer fills in credit card information
  6. System authorizes purchase
  7. System confirms sale immediately
  8. System sends confirming email to customer

**Alternative: Authorization Failure**

At step 6, system fails to authorize credit purchase  
Allow customer to re-enter credit card information and re-try

**Alternative: Regular Customer**

3a. System displays current shipping information, pricing information and last four digits of credit card information  
3b. Customer may accept or override these defaults  
Return to primary scenario at Step 6.

Source: M. Fowler and K. Scott *UML Distilled* 2<sup>nd</sup> Edition

## Use Case Diagrams

- Depicts
  - Actions by people and systems outside your system
  - What your system does in response to actions

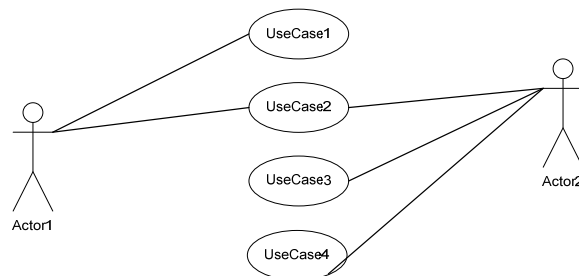

## Example: Buy a Product

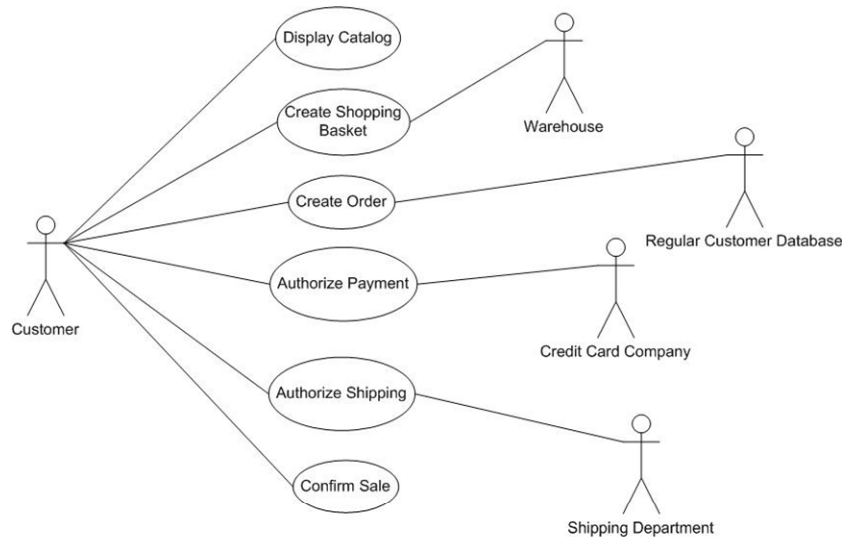

## Sequence Diagram

- Depicts detailed behavior over time within one path or scenario of a single functional requirement

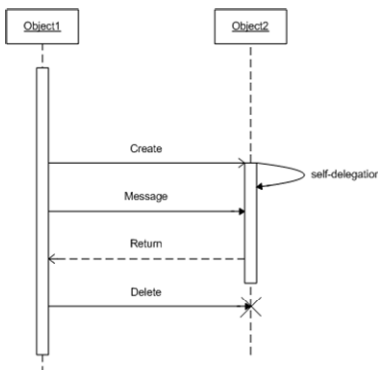

## Example of Sequence Diagram

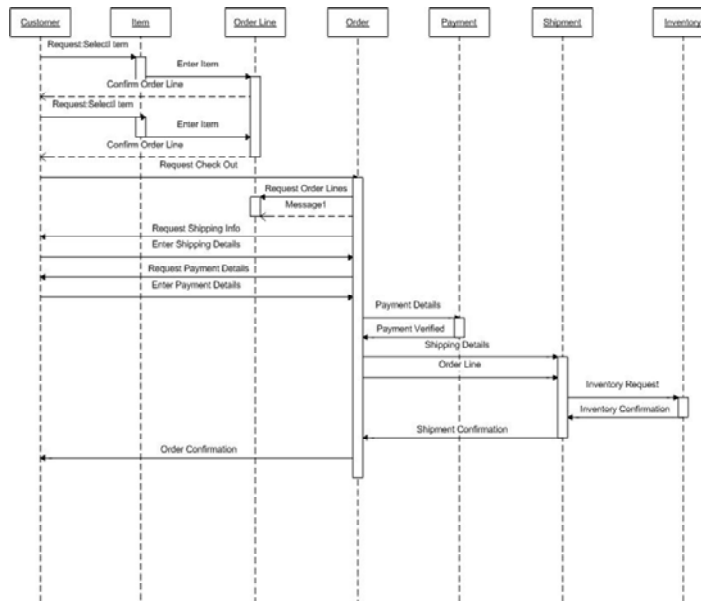

## Class Diagrams

- Classes of objects and interfaces within the design of system as well as relationship between them

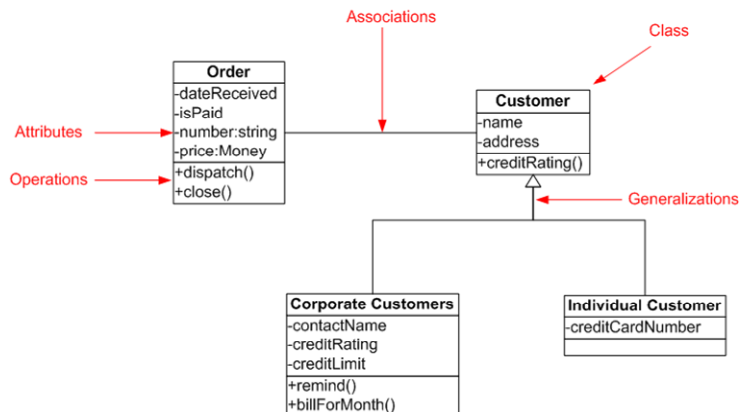

# State Diagram

- Depicts how the state of system change in response to internal and external events

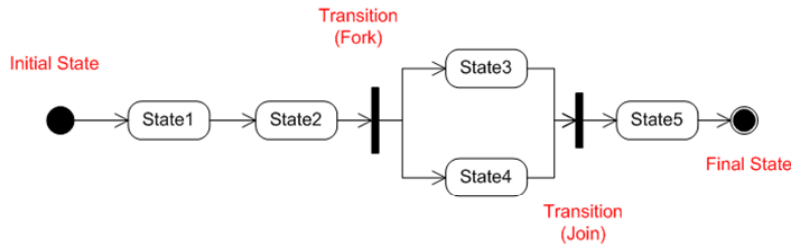

# Activity Diagrams

- Similar in concept to state diagram, but show sequence of activities which cause a change in state of system

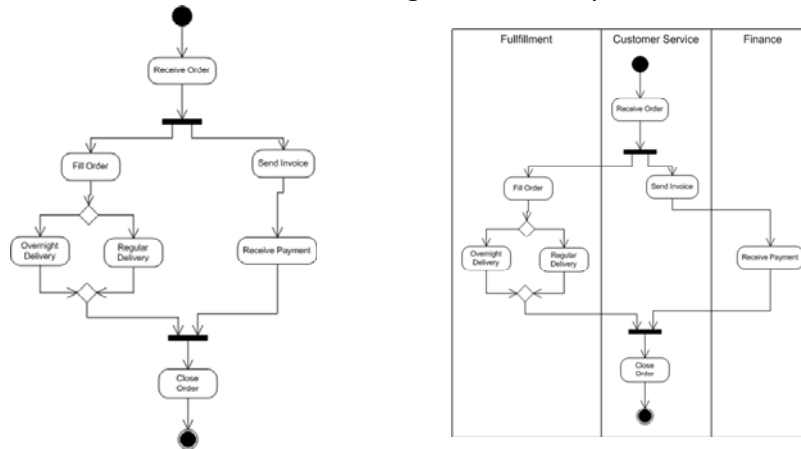

# Laboratory Exercise

- Develop Use Case Diagrams and Activity for Bryan/College Station Mobility Initiative – Regional Signal Control

## System Engineering Process: Integration and Validation

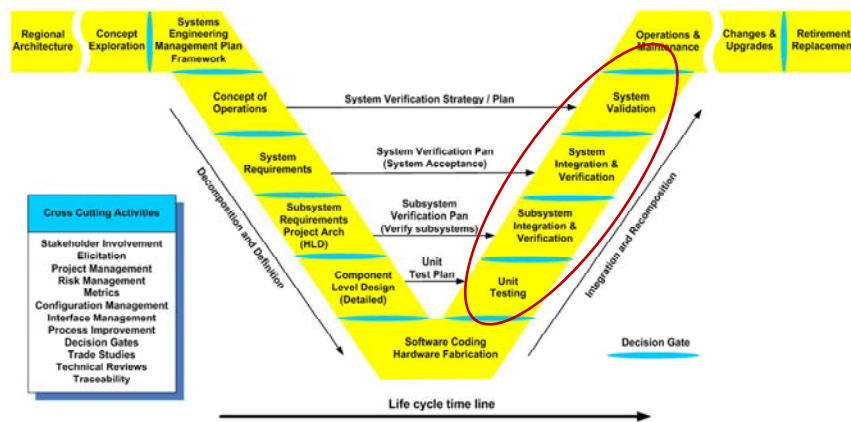

## Validation vs. Verification

- Verification
  - Does the product meet its requirements?
  - Built the product correctly
- Validation
  - Does the product fulfill its intended use?
  - Built the right product

## Types of Test Plans

- Component Testing
- Integration Testing
- System Testing

## Example: Functional Test Plan

STEP	INPUT	SCRIPT	EXPECTED RESULT
1	None	Test winter travel links	
1.a		Select Chain Laws	Opens: Pages/RMap.asp?curRegion=ChainLaws
1.b		Select Traction Tires	Opens: Pages/RMap.asp?curRegion=TractionTires
1.c		Select Minimum Chain Requirements	Opens: Pages/RMap.asp?curRegion=MinChainReqs
2	None	Test related links	Each link opens a browser window with an external URL

## Example: CHART R3B2 Integration Test Plan/Procedures

### 3.1 Pending Traffic Events

#### 3.1.1 Create Pending Incident Event

##### 3.1.1.1 Purpose

The purpose of this test is to create a Pending Incident Event.

##### 3.1.1.2 Set-up / Preconditions

A user should be logged in. User should have permissions to manage traffic events.

##### 3.1.1.3 Requirements Tested

4.1.3.3, 4.2.1.7

##### 3.1.1.4 Test Procedure

Date/Time of Test: \_\_\_\_\_

Tester(s): \_\_\_\_\_

Step #	Procedure	Expected Results	Pass / Fail/Comments
1	Log in, and click on the Traffic Events, open View Pending Events. Add New Pending Traffic Event	New Pending Traffic Event popup is displayed in the working window.	
2	Create a pending incident event with all data elements (incident info, participant, roadway conditions, lane, RPI)	New pending event shall be in the list of pending events	



# Example: System Verification Testing Procedures

## 3.1.3 Verify MdTA Camera Function with SHA Monitor

A privileged individual will verify MdTA Camera Function with SHA Monitor

### 3.1.3.1 Environment

This test case is applicable to all Configurations. Refer to Section 2.0 of the Test Plan - Volume 1 for a description of the configurations.

### 3.1.3.2 Data

Refer to the Test Cases listed below for the applicable test data.

### 3.1.3.3 Test Procedure

Test Step #	Input Action	Expected Result	Requirement #
	<b>Verify MdTA Camera Function with SHA Monitor</b>		3.3 3.3.1 3.3.6
1	The operator selects camera FMT Cam1 (SVFT). If not in online mode, place on online.		
2	The operator selects "display"	The local monitor names are listed with empty check boxes	
3	The operator checks the box for "NODE1 MON1 (n1)".		
4	The operator pushes "OK"	FMT Cam1 (SVFT) <sub>3</sub> displayed on monitor NODE1 MON1.	
5	The operator selects the link for FMT Cam 1.		
6	The operator selects the link for "Request Control" on the left.	The camera control window appears	
7	The operator hits the "up" arrow to move the camera up.	The camera moves up, pointing to the ceiling.	
8	The operator hits the "left" arrow to move the camera to the left.	The camera moves to the left.	
9	The operator selects the "close" button to end the camera control session.	The camera control window goes away.	

# Example Test Form

## Appendix A – Test Data Sheet Templates

System Factory and Operational/Acceptance test Results for R3B2 will be recorded on Test Data Sheets as shown below.

### TEST DATA SHEET

Software Version Number: R3B2

Date:

Configuration Number: 1

Test Area: Area to be Tested

Test Case 1 – Name of Test Case

Objective:

[Insert the objective of the Test Case]

Test Step #	S	SA	U	COMMENT	PR NUMBERS
1					
2					
3					
4					
5					
6					
7					
8					

(Legend: S = Successful, SA = Successful with Anomaly, U = Unsuccessful)

PASS \_\_\_\_\_ FAIL \_\_\_\_\_  
(Signature) (Date)

Systems and Systems Engineering

# CONTRACTING

## Deploying ITS Projects

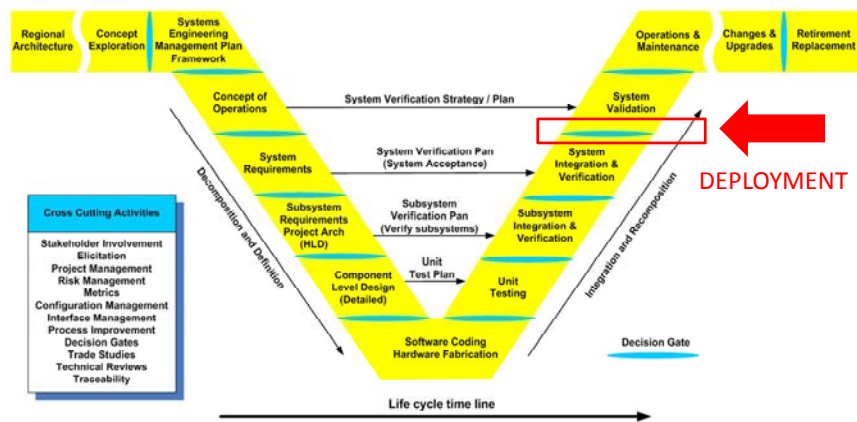

## References/Sources of Information

- *Guide to Contracting ITS Services*. NCHRP Report 560.

## ITS Acquisition Decision Model

- Step 1. Make Initial Decisions
- Step 2. Determine Work Distribution
- Step 3. Define Project Category
- Step 4. Determine Agency Capability Level
- Step 5. Select Applicable System Engineering Process and Candidate Procurement Package
- Step 6. Apply Differentiators
- Step 7. Assess Package and Make Final Selection
- Step 8. Define Contract Scope, Terms, and Conditions.

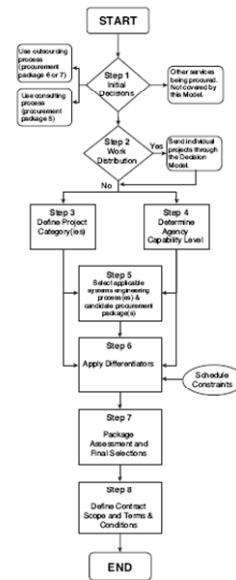

## COTS versus Custom System Development

- COTS= Commercial “Off-the-Shelf”
- Advantages
  - “Bugs” and “Kinks” already worked out
  - Capitalize on lessons learned by others
  - Generally less expensive
  - Something tangible to “see and touch”
  - Most agency procurement processes designed to support
- Disadvantages
  - May not be “latest” and “greatest”
  - May not support specialized or all needed functionality
  - “Logged in” to a technology (creating a legacy system)
  - May still need integration contract

## Outsourcing

- **Outsourcing** – process of contracting with either private or public sector vendors and service suppliers to obtain services that have traditionally been, or would otherwise be, performed by staff. Responsibility to public for the quality, reliability, and cost-effectiveness of the services still remains with the public agency
- **Commercialization** – a subset of outsourcing activities, in which the transfer of service provision is made from the public agency to a private for-profit organization whose activities are nevertheless still controlled and regulated by the public agency in an ongoing relationship
- **Privatization** – a public policy designed to transfer activities from the public to the private sector
- **Public-Private Partnerships** – expression used to describe certain forms of privatizing actions or relationships involving public agencies and private interests.

Source: NCHRP Synthesis 246

# The Procurement Process

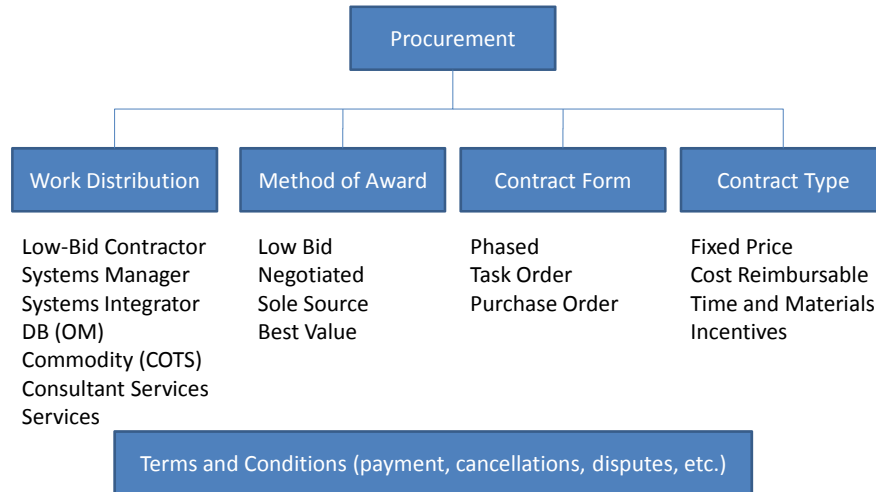

Source: NCHRP Report 560

## Work Distribution

- Low-bid contractor
- Systems manager
- Systems integrator
- Design-build (operate and maintain) (DB[OM])
- Commodity
- Consultant Services
- Services

## Methods of Award

- **Low Bid** – contracting method that employs competitive bids, public openings of bids, and contractor selection based on the lowest price offered.
- **Negotiated** – commonly used for projects oriented toward obtaining services or where design/contract requirements not well defined. Uses a number of different procedures in making awards. Commonly used to select individuals or consultants as opposed to equipment. Evaluation of technical approach, qualifications, and experiences.
- **Sole-Source** – selection of a contractor without competition. Commonly used with matching legacy equipment or systems.
- **Best Value** – beginning to be used more frequently with ITS. Selection made based on weighted combination of evaluation criteria. Criteria may include technical approach, qualifications, experience, and price. Frequently a combination of negotiated and low bid.

## Contract Form

- **Phased contracts** – divide the work into sets of predefined activities (or phases) with specified deliverables
- **Task order (or indefinite delivery) contracts** – used with contracts in which required supplies and services are unknown (“umbrella” contracts)
- **Purchase orders** – form of a sole-source contract usually containing standard set of terms and conditions and a relatively brief description of work

## Contract Types

- **Firm, fixed price**– Contract sets price of services/equipment. Contractor assumes full responsibility of the costs and any profit or loss at a fixed price
- **Cost reimbursable** – Contractor paid (reimbursed) for actual costs of performing the work. Contractor will charge a fixed fee that defines profit for project.
- **Time and materials** – Contractor paid for actual costs of performing the work and a percentage fee is added to all payments.
- **Incentive/disincentive** – Contractor responsible for performance costs. Profit and/or fee incentive /penalties is dependent upon the uncertainties associated with the desired outcomes of the procurement. Incentives/penalties can be added to the three other contract types.

## Handouts

- Procurement Packages
- Common Contact Terms and Conditions  
Definitions

## Factors Affecting the Procurement Process

- An understanding of the project specifics
- An understanding of the risks associated with different procurement types and packages
- An awareness of federal, state, and local procurement regulations, policies, and guidelines
- Familiarity and experience with project management principles of high-technology projects

## Federal Acquisition Regulations

- All Executive Branch agencies are required to follow Federal Acquisition Regulations
- The Federal Acquisition System will—
  - 1) Satisfy the customer in terms of cost, quality, and timeliness of the delivered product or service by, for example—
    - i. Maximizing the use of commercial products and services;
    - ii. Using contractors who have a track record of successful past performance or who demonstrate a current superior ability to perform; and
    - iii. Promoting competition;
  - 2) Minimize administrative operating costs;
  - 3) Conduct business with integrity, fairness, and openness; and
  - 4) Fulfill public policy objectives.
- <http://www.arnet.gov/far/>



## State and Local Procurement Practices and Policies

- General Procurement and Contracting requirements
  - Texas DOT: <http://www.txdot.gov/business/>
- Disadvantaged Business Enterprises (DBE)
  - created to provide a level playing field for small minority- and women-owned companies
- Historically Underutilized Businesses (HUB)
  - created to promote full and equal procurement opportunities for small minority- and women-owned businesses
- Small Business Enterprises
  - offers small businesses another avenue of maximizing their opportunities of doing business with TxDOT.
  - applies only to highway construction and maintenance projects that are funded entirely by state and/or local funds.

## Elements of Contract

- Parties to the contract
- Scope of the contract
- Compensation and method of payment
- Extras
- Assignment of claims
- Agency-furnished property
- Order of precedence
- Commercial Warranty
- Patent rights
- Multi-year contracts contingent upon appropriations
- Termination of default
- Termination of convenience
- Execution and commencement of work
- Delays and extensions of time
- Modifications
- Multiple contract awards
- Liquidated damages
- Variations in estimated quantities
- Suspension of work
- Incorporation by reference
- Specifications
- Delivery and acceptance
- Intellectual property
- Contractor's invoices
- Conflicting terms

Systems and System Engineering

## **MANAGING ITS PROJECTS**

### **Project Management Plan**

- Generally required for projects using Federal funds
- Lays out activities, resources, budget and timeline – what is to be done, by whom, with what funds, and by when
- Standard project management tools
  - PERT Chart
  - Gantt Chart

## Project Monitoring and Control

- ✓ Are the project's goals and objectives clear? Do they need to be further defined before project planning takes place?
- ✓ Are the task descriptions, as well as the identification of inputs and outputs prepared for the project activities?
- ✓ Are the task descriptions, as well as the estimates for cost and time [needed for the budget and the schedule], being prepared by people familiar with the underlying processes?
- ✓ Are the task descriptions, budget, and schedule accepted by the performing organizations?
- ✓ Do the financial tracking processes provide accurate and timely information on team expenditures?
- ✓ Are regular, periodic [usually weekly] meetings being held with each active task team?
- ✓ Do these meetings review progress on the activity by looking at the preparation of products [outputs], expenditures, and progress relative to the schedule?
- ✓ When an activity encounters a problem, are intervening actions done in a timely and effective manner?

## Example: Project Tracking Performance Measures

Performance Measures		
Technical		Programmatic
Development Progress	System Performance	
# of requirements defined	Transit vehicle maintenance database usage	# of tasks performed
# of requirements predicted	# disk space allocated	# of planned tasks scheduled
# of SW modules completed	# of times traffic signal equipment reports faults	Cost as of today
total # of planned installations	Total # traffic signal equipment faults	Budget as of today
# of field sites installed	Failure rate of DMS equipment	
Total # of planned installations	Predicted failure rate	
# of acceptance tests passed		
Total # of acceptance tests		

## Risk Management

- RM is identification and control of risks during ALL phases of the project life cycle.
- Goal of RM
  - Identify problems BEFORE they occur
  - Plan for their occurrence
  - Monitor system development so that early action can be taken
- Expression of Risk
  - “If <situation> then <consequence>.”

## Areas of Risk in ITS Project

- Technical
  - Technologies not widely deployed
  - Project team unfamiliar with technology
  - Requirements not well defined
  - Development and test facilities inadequate
  - Technical documentation not reviewed or adequate
- Institutional
  - Formal agreements between agencies (MOUs, IACs, etc.)
  - Regulations or agency hurdles
- Schedule
  - Too aggressive
  - Impacts of slippages on final deliverable
  - Schedule dependences (what is in critical path?)

## Areas of Risk in ITS Project (cont.)

- Funding
  - Total or partial funding
  - Long-term operational and maintenance support
- Personnel
  - What happens if there is loss of key agency or contractor personnel?
  - Adequate experience
- Environmental
  - Effects of adverse weather on deployment schedule
  - Environmental restrictions (height, sight obstruction, colors, etc.)
- Commercial
  - Adequate time/vendors of equipment

## Configuration Management

- “A management process for establishing and maintaining consistency of a product’s performance, functional, and physical attributes with its requirements, design, and operational information throughout its life.”  
(ANSI/EIA 649-1998)

## Configuration Management Activities

- Configuration management planning – what needs to be controlled, how changes are controlled, how to track changes, and how to verify CM process is working
- Configuration identification – identifying the functional and physical characteristics of a configuration item
- Configuration change management – control changes to those characteristics
- Configuration status accounting – Keep track of status of changes (proposed, approved, or implemented)
- Configuration auditing – verifying the CM procedures are being followed

## Configuration Management References

- TMC Pooled-Fund Study *Configuration Management for Transportation Management Systems*  
(<http://ops.fhwa.dot.gov/freewaymgmt/publications/cm/handbook/index.htm>)
- *A Guide to Configuration Management for Intelligent Transportation Systems*  
([http://www.itsdocs.fhwa.dot.gov/JPODOCS/REPTS\\_TE/13622.html](http://www.itsdocs.fhwa.dot.gov/JPODOCS/REPTS_TE/13622.html))



## **Appendix C: Lecture Slides for Module 3. Traffic Sensing Technologies**





# Traffic Sensing Technologies

## Module 3

### References

- L. Klien, M. Mills, and D. Gibson. *Traffic Detector Handbook: Third Edition – Volume I*. Report No. FHWA-HRT-06-108. U.S. Department of Transportation, Federal Highway Administration, October 2006.
- R. Gordon, and W. Tighe. *Traffic Control Systems Handbook*. Report No. FHWA-HOP-06-006. U.S. Department of Transportation, Federal Highway Administration, October 2005.

## Definition

- National Electronic Manufacturers Association's (NEMA) definition of a vehicle detection system: “ ... a system for indicating the presence or passage of vehicle.”
- More types of sensors
  - Environmental sensing stations
  - Automatic vehicle identification system
  - Tracking systems
  - Positioning systems
  - Air quality
  - Passenger counting systems
  - Vehicle intrusion systems

## Types of Detection Systems

- Intrusive
  - Embedded in the pavement
  - Embedded in subgrade
  - Temporarily /permanently affixed
- Non-Intrusive
  - Above the roadway itself
  - Along the roadway
- Vehicle-based

## Inductive Loop Detector

- Still workhorse of transportation detection
- Senses presence of conductive metal object by inducing current in the object, which reduces loop inductance

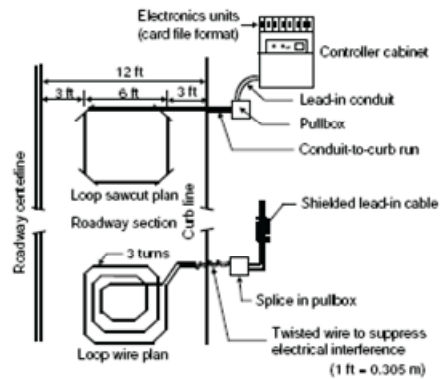

## Example of Inductive Loop Detectors





# Typical Loop Lead-In Configurations

## Without Curbing

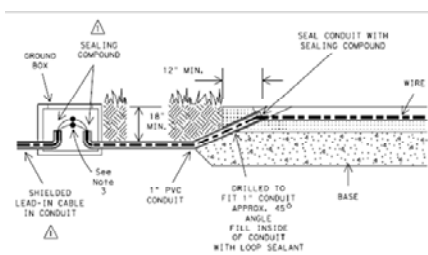

## With Curbing

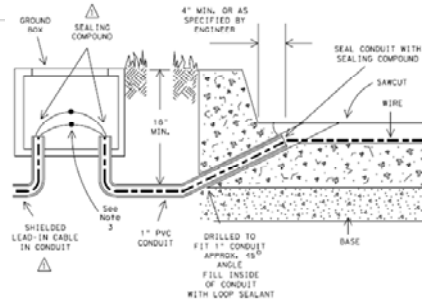

# Magnetic Sensors

- Detect the presence of a ferrous metal object through perturbations (magnetic anomaly) they cause in Earth's magnetic field

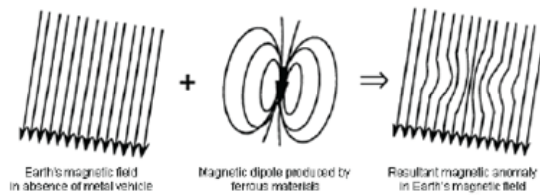

(a) Magnetic anomaly induced in the Earth's magnetic field by a magnetic dipole.

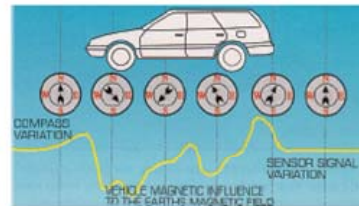

(b) Perturbation of Earth's magnetic field by a ferrous metal vehicle  
(Source: Nu-Metrics, Vanderbilt, PA).

## Video Image Processor

- Also called....
- VIVDS (Video image vehicle detection system)
- VDS (Video Detection Systems)

## Freeway Application of VIVDS

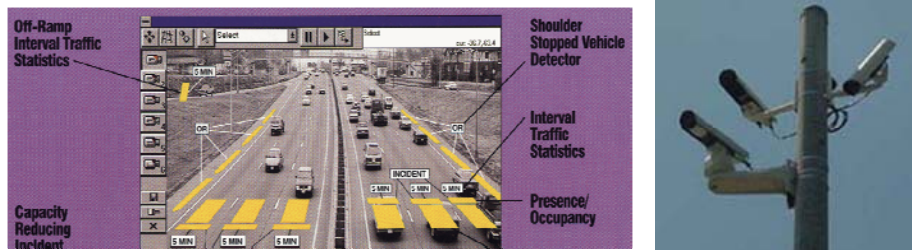

## Intersection Application of VIVDS

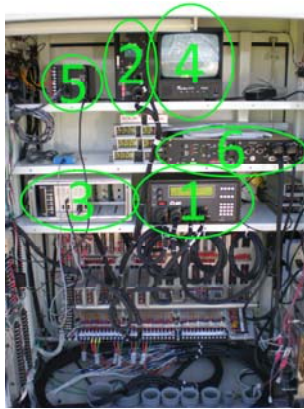

## Microwave Radar Sensors

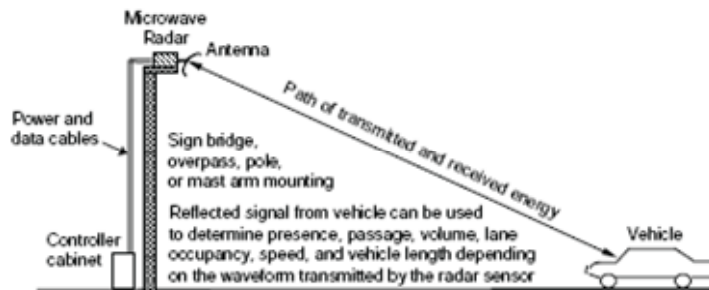



## Infrared Sensors

- Active: Transmits infrared energy from detector and detects the waves that are reflected back.
- Passive: Doesn't transmit energy; detects energy from vehicles, roadway, and other objects, as well as energy from sun reflected by vehicles

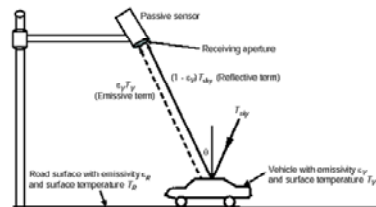

## Acoustic

- Measure vehicle passage, presence, and speed by passively detecting acoustic energy or audible sounds produced by vehicular traffic.

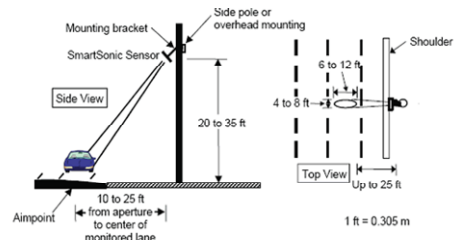

# RFID / Electronic Toll Collection

- RFID = Radio-Frequency Identification



# RFID Applications



# License Plate Recognition

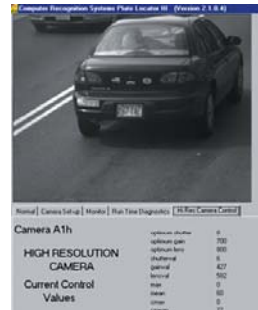

# Overheight Detection Systems

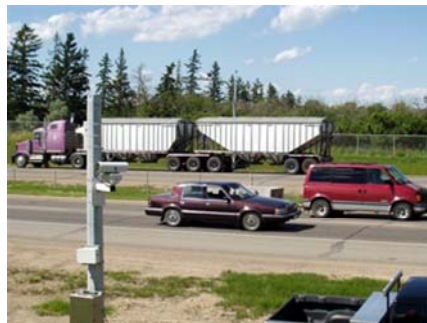

# Weigh-In-Motion

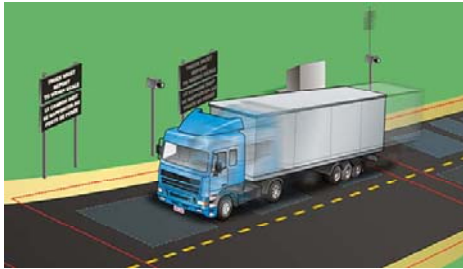

# Road Weather Information



# Automated Enforcement



Automated Speed Enforcement

Red-Light Running

# Positioning Systems



Traffic Sensing Technologies

## **VIDEO SURVEILLANCE**

### **Closed Circuit Television (CCTV)**

- Use of video cameras to transmit a signal to a specific place on a limited set of monitors
- Differs from broadcast television in that signal NOT openly transmitted (although it can employ point-to-point wireless links)



## Video Transmission

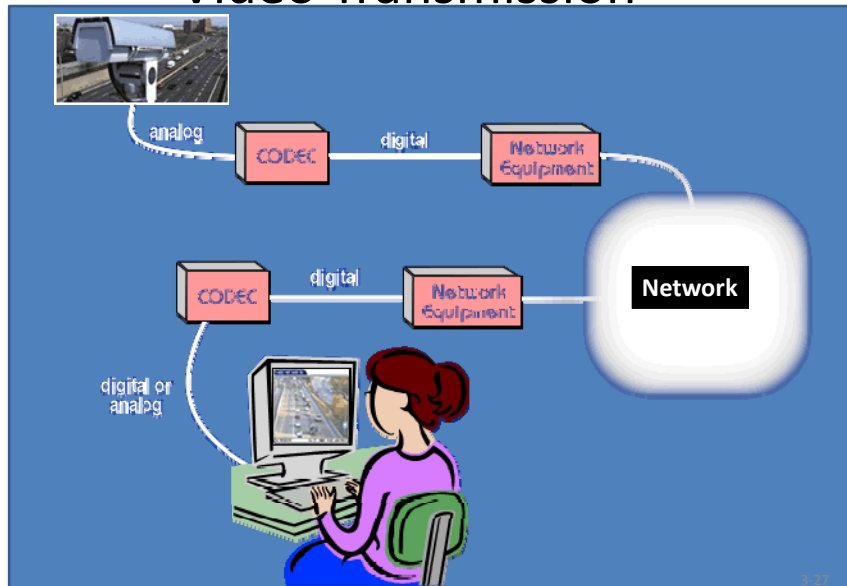

## Uses of CCTV

- Monitoring traffic movements
  - Freeway mainlanes, HOV, entrance and exit ramps
  - Intersection operations
- Real-time command and control decisions support for operators
  - When to implement new control
  - Monitor effects of control change
  - Verify message display on DMS

## Components of CCTV Systems



## Examples of Camera



Source: <http://www.cohu-cameras.com>



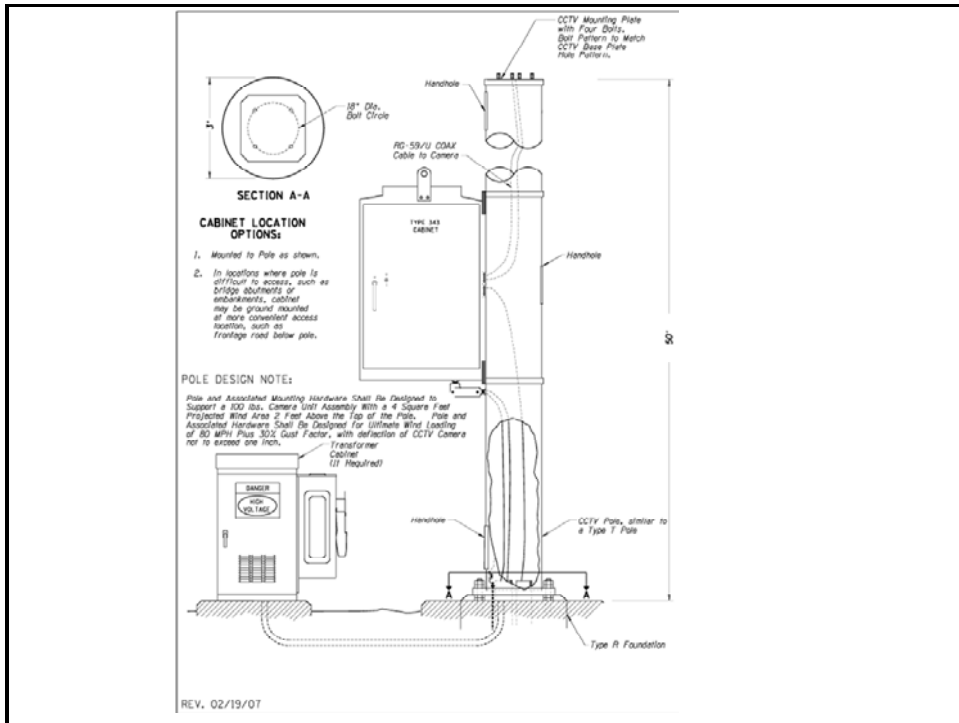

## Video

- Color representation
  - Describes each piece of a picture as a color
- Video encoding
  - Reduces space requirements for each picture
- Video transmission
  - Moves the pictures

## Color Representation

- Numerous color models exist
- Can you name some?
  - RGB (red-green-blue)
  - CMYK (cyan-magenta-yellow-black)
  - HSV (hue-saturation-brightness)

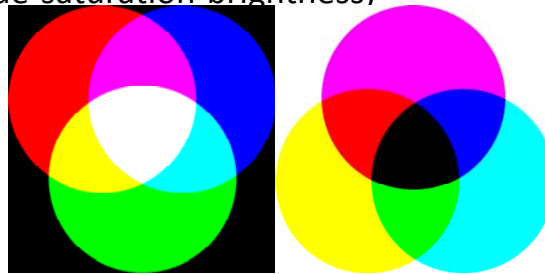

3-33

## Video Encoding

- Typical video technologies are analog
- 3 formats:
  - Composite (NTSC)
  - S-video (brightness and color separated)
  - Component (RGB separated)

3-34

## Video Encoding

- Digital transmission will require compression
  - Reduces bandwidth requirements
- Encoding is the process of conversion from analog to digital

3-35

## Video Encoding Methods

- Motion JPEG (Joint Photographic Experts Group)
- MPEG-1 (Moving Pictures Experts Group)
- MPEG-2
- MPEG-4

3-36

## Motion JPEG

- Still images compressed using JPEG compression
- Removes color change information
- Encodes individual video frames into JPEG frames and sends as a video stream
- Least amount of complexity (costs less)
- Doesn't compress as well and requires most bandwidth

3-37

## MPEG-1

- Eliminates redundant picture information that exists between adjacent frames
- Well established as a standard (more products can decode and use an MPEG-1 stream than any other standard)
- Not a large variety of options
- Does not easily encode higher quality video streams such as HDTV

3-38

## MPEG-2

- Corrects functional limitations of MPEG-1
- Scalable and better picture quality
- Supports interlaced video encoding by design
- Used in many applications including DVDs, HDTV, satellite TV, and DVRs
- Requires more CPU horsepower to decompress

3-39

## MPEG-4

- Developed to deliver quality video streams over a variety of devices
- Designed to handle low-bandwidth video
- Fewer products that support MPEG-4 than MPEG-2 or MPEG-1
- Encoders and decoders are more expensive because of their newness
- Decompression is slower (possible latency)

3-40

## Codecs

- Equipment that COmpresses and DECcompresses video signals
- Beware of interoperability



3-41

## Video Communication

- Frame rate
  - How many times picture refreshes in given time
  - Expressed in frames per second
- Resolution
  - Size of picture
  - Measured in pixels
- Color depth
  - Information about each pixel
  - Expressed in bits or bytes

5-42

## Video Communication

### Resolution

1 frame @ 720 x 576 resolution = 414,720 pixels per frame

### Color Depth

414,720 ppf x 3 bytes per pixel = 1,244,160 bytes per frame

### Frame Rate

1,244,160 bytes per frame x 30 fps = 37,324,800 bytes per second

### Bandwidth

37,324,800 Bytes per second = 298,589,400 bps = 298.6 Mbps

5-43

## Design/Placement Guidelines

- Viewing distance =  $\frac{1}{4}$  to  $\frac{1}{2}$  mile each direction
- Factor affecting camera views
  - Mounting height
  - Terrain
  - Number of horizontal and vertical curves
  - Overpasses and sign supports
  - Environmental
    - Weather
    - Sun angle
  - Camera Stability

## Video Transmission

- Transmission Control Protocol/Internet Protocol (TCP/IP) is most common method of transmitting digital video
- Two mechanisms:
  - Unicasting
  - Multicasting

3-45

## Unicasting

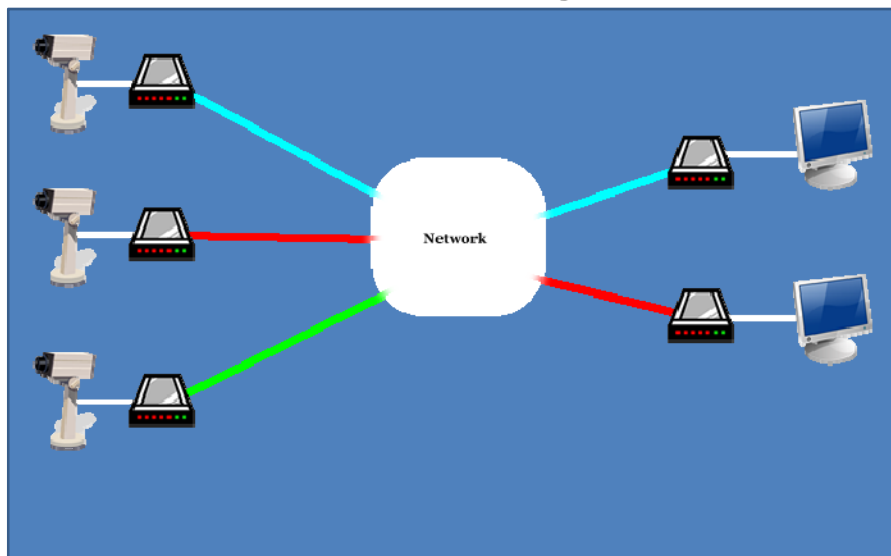



## Unicasting

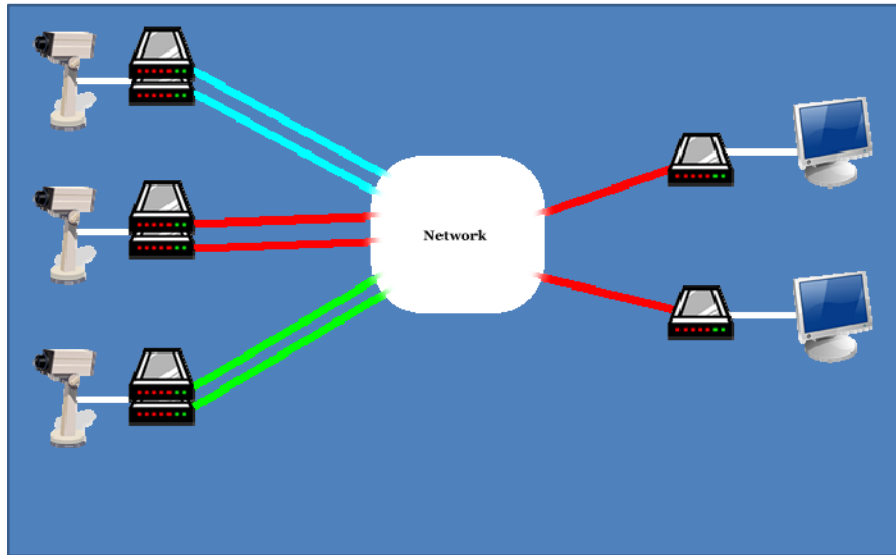

3-47

## Multicasting

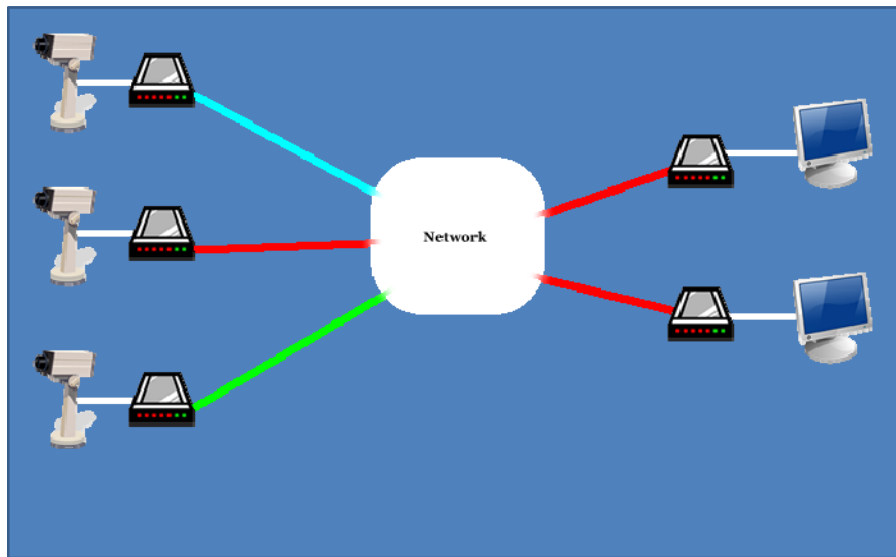

3-48

**Appendix D: Lecture Slides for Module 4. Communications Systems for ITS Applications**



# Communications Systems for ITS Applications

## Module 4

### References

- S. Leader. *Telecommunications Handbook for Transportation Professional: The Basics of Telecommunications*. FHWA-HOP-04-034. Federal Highway Administration, August 2004.
- R. Brydia, B. Brackin, J. Johnson, G. Thomas, and K. Balke. *Wireline Communications: A Design Guidebook for Intelligent Transportation Systems. Training Course*. Product Number 5-4969-01-P1. Texas Transportation Institute, October 2007.
- R. Gordon, R. Reiss, W. Dunn, and D. Morehead. *Communications Handbook for Traffic Control Systems*. FHWA-SA-93-052. Federal Highway Administration, April 1993.

## BASIC TERMINOLOGY

### Fundamental Elements of Communications System

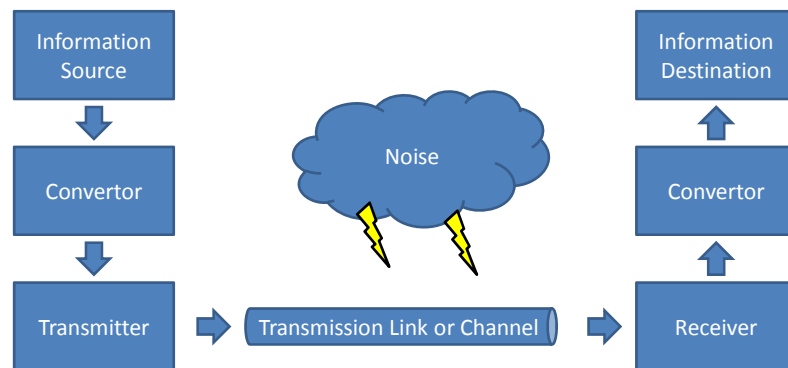

Transmission Media = form factor for pathway

# Analog Transmission

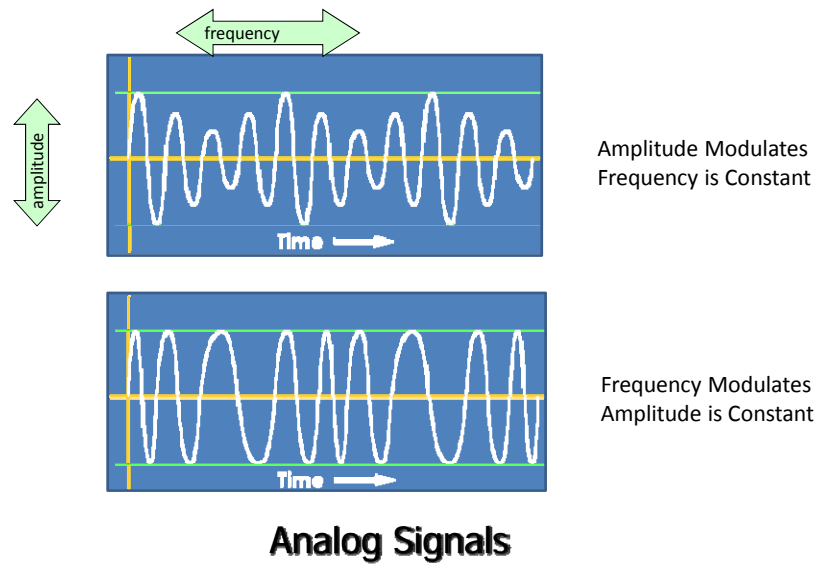

2-5

# Digital Transmission

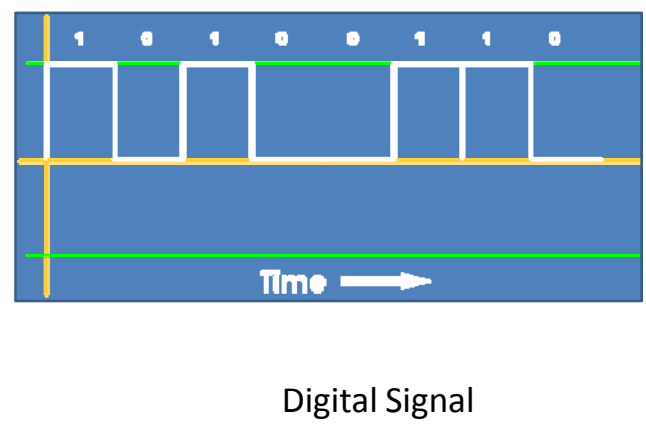

2-6

## Bits and Bytes

- A bit is the smallest unit of information
  - Either a “1” (on) or a “0” (off)
- A byte is made up of 8 bits
  - Represents a single character



2-7

## Parallel versus Serial Transmission

### Parallel Transmission

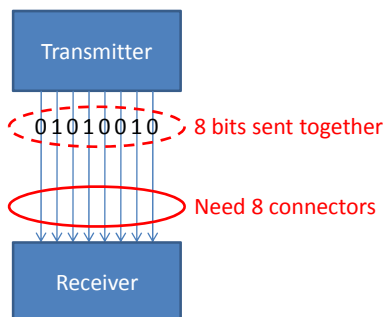

### Serial Transmission

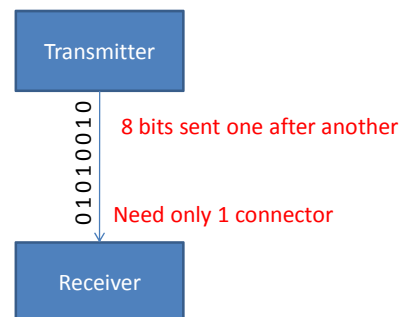

## Transmission Mode Characteristics

Mode	Data Flow Detection	Characteristics	Comments
Simplex	Data flow in one direction only	<ul style="list-style-type: none"> <li>•Does not provide verification that data were received and acted upon</li> <li>•Does not provide answer-back, status reporting or validity</li> </ul>	<ul style="list-style-type: none"> <li>•Commercial radio and television are examples</li> <li>•Traffic control systems provide no return information to a master controller or traffic operations center use this mode</li> </ul>
Half Duplex	Data flow in either direction, but only in one direction at a time	<ul style="list-style-type: none"> <li>•Requires modem at each end of the line</li> <li>•Requires control capability to assume proper operation</li> <li>•Uses latency time or turnaround time (the time period required to turn the line around) for the process in which the direction of data transmission is reversed, which can be time consuming</li> </ul>	<ul style="list-style-type: none"> <li>•In a copper wire transmission media, HDX required two wires but may be used with four wires (four wires provide improved interference characteristics)</li> </ul>
Full Duplex	Data flow possible in both directions at the same time	<ul style="list-style-type: none"> <li>•Acts like two simplex channels in opposite directions</li> <li>•Permits independent, two-way, simultaneous data transmission</li> <li>•May raise cost of channel</li> <li>•Reduces the one-way capacity if frequency multiplexing is used on a single channel.</li> </ul>	<ul style="list-style-type: none"> <li>•In copper wire transmission system, some FDH modems require four wires while others require only two wires. In the later case the modem divides the channel into two subchannels to achieve simultaneous bidirectional service</li> </ul>

## Signal Attenuation

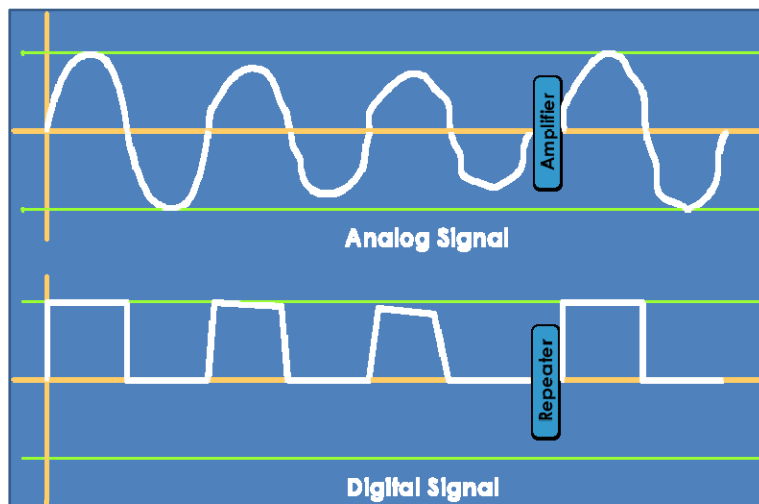



# Multiplexing

- Process of combining two or more information channels into a single transmission media

## Modem Versus Codec

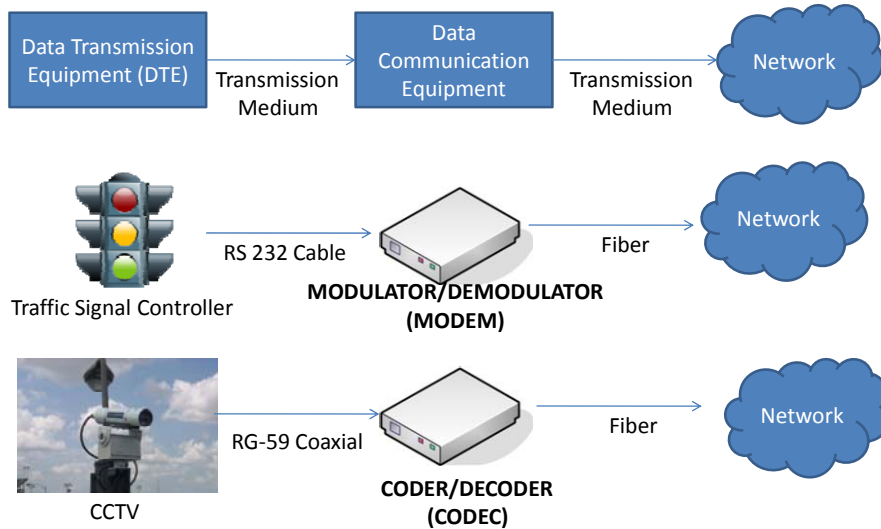

## Bandwidth

- How much data can be transmitted in a given amount of time

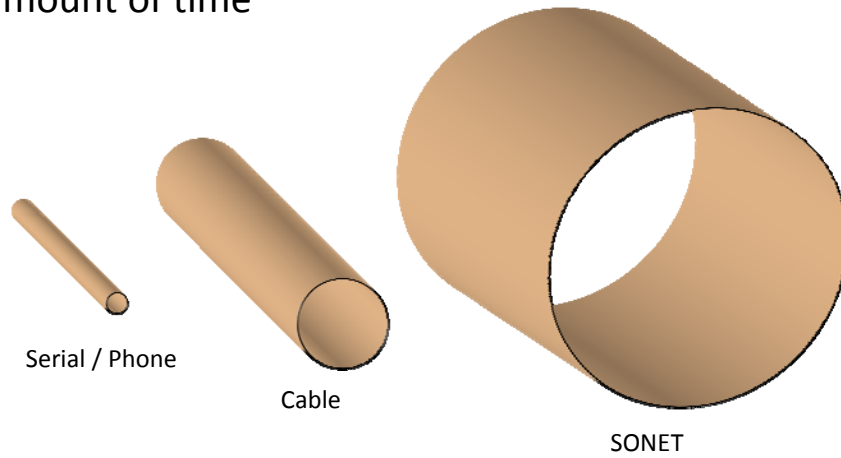

Communications Systems for ITS Applications

## TRANSMISSION MEDIA

## Transmission Media

- Pathway over which information flows
- Factors to consider
  - Data needs
  - Costs
  - Ease of installation and maintenance
  - Efficiency of transmission
- Pick right transmission media for job!

## Media – Twisted Pair

- Literally – pairs of wires twisted together
- Why do they twist?
  - Cancels out electrical “noise”
- Examples
  - Phone line, computer cables
- Six categories
  - “Cat” 1 = voice only (phone wire)
  - “Cat” 6 = high-speed data



# Media – Coaxial

- Layered media
  - Copper wire (innermost)
  - Plastic insulation
  - Metal shield
  - Rubber sheath (outermost)
- Various types
  - RG-6, RG-11, RG-59
  - Impedance, loss, outer conductor

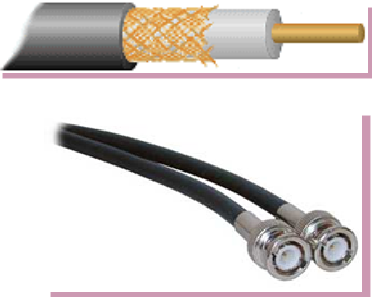

# Media – Coaxial

- Various connector types

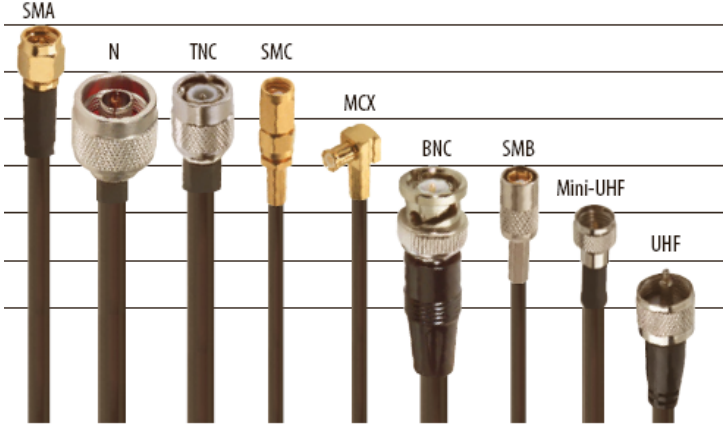

## Media – Fiber

- Layered media
  - Jacket (outermost)
  - Strength member
  - Buffer
  - Cladding
  - Glass core (innermost)
- Resistant to light and moisture
- Data can move faster and farther

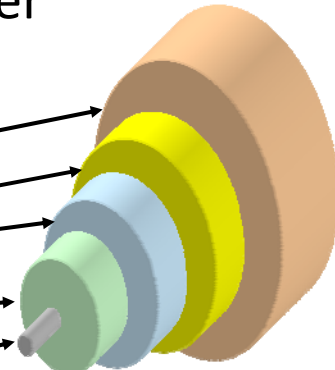

## Media – Fiber

- Example cable assemblies
  - Duplex Zipcord
  - Breakout cable
  - Messenger cable
  - Hybrid cable

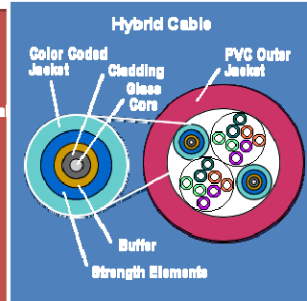
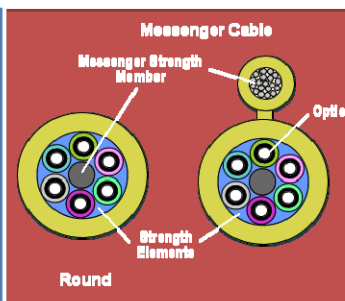
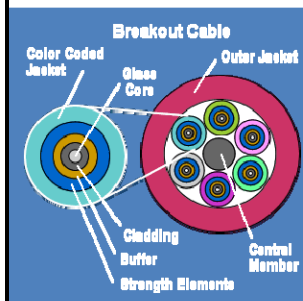
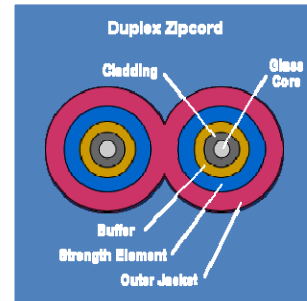

## Media – Fiber

- Single mode
  - One stream of light
  - Longer distances
- Multimode
  - Multiple streams of light (different frequencies)
- Special connectors



## Comparison of Single and Multimode Fiber

Characteristic	Single Mode	Multimode
Bandwidth	Virtually unlimited	Less than virtually unlimited
Signal Quality	Excellent over long distances	Excellent over short distances
Primary Attenuation	Chromatic Dispersion	Modal Dispersion
Fiber Types	Step Index & Dispersion Shifted	Step & Grade Index
Typical Application	Almost anything (including Ethernet)	Analog Video, Ethernet, Short range communications

Source: *Telecommunications Handbook for Transportation Professionals*

## Wireless Communications Needs

- Vehicle-to-Vehicle
- Roadside-to-Vehicle Broadcast
- Mobile wide area
- Fixed wide area
- Short-range

## Wireless Technology Options

- Radio frequency communications
  - Spread Spectrum Radio
    - Spreads transmission over group of radio frequencies
      - Direct Sequence
      - “Frequency Hopping”
    - Frequencies: 900 MHz, 2400 MHz and 5800 MHz
- Microwave communications
  - Fixed point-to-point between major communication nodes
  - Frequencies
    - FCC license: 6 and 11 GHz
    - Unlicensed: 900 MHz, 2 and 23 GHz
  - Operate over distances of 20 miles
- Infrared communications

## ITS Shared Wireless Systems

System	Spectrum Description	Deployment Situation
DGPS Broadcasting	200-500 kHz	Nationwide deployment
Highway Advisory Radio (HAR)	Licensed system with limited power; Sharing spectrum with AM & FM broadcasts	AM analog HAR widely used; digital HAR and FM HAR started to be deployed
Safety Warning System	24 GHz (shared with police radar detector)	Operational test completed; started to be deployed
Low speed AM & FM subcarriers	Sharing with AM & FM broadcasting	Several commercial vendors started to provide traffic information services
High speed FM subcarriers	Sharing with FM broadcasting	Several commercial vendors started to provide traffic information services; in process of standardizing

Source: Yan, et. al. *TRR 1788*

## Existing IS-Related Commercial Wireless Systems

System	Spectrum Description	Deployment Situation
Paging system	150 MHz, 450 MHz, 900 MHz	43.5 million one-way and 150,000 two-way pager users (1998)
Cellular system	800 MHz, 1900 MHz	70% US land mass
Cellular Digital Package Data (CDPD)	Cellular frequency band	> Half of geographic US
E-911 system	Cellular frequency band	
Radio data networks	800 MHz	90% of US business population
ESMR system	800 MHz (e.g., Nextel)	
Satellite communications	GEO System (e.g., OmniTRACS) Little LEO , Big LEO	Several systems have been used in CVO fleet management

Source: Yan, et. al. *TRR 1788*



## ITS Dedicated Wireless Systems

System	Spectrum Description	Deployment Situation
Highway maintenance radio	33-37 MHz; 45-47 MHz; 150-159 MHz	Analog voice/data communications for maintenance personnel and traffic controllers
220 MHz	5 narrow-band frequencies assessed by NTIA	Operational field test for advisory information services
Transit wireless communication systems	150 MHz, 400MHz, 800 MHz, and 900 MHz	From single simplex analog system to sophisticated digital trunked systems; supports AVL and CAD functions
Public safety wireless communications	138-144 MHz; 148-174 MHz; 406-420 MHz; 764-776 MHz; 794-806 MHz; 806-824 MHz; 851-869 MHz	From single simplex analog system to sophisticated digital trunked systems; supports AVL and CAD functions; Some state-wide multi-agency systems
Spread spectrum radio	902-928 MHz (unlicensed) 2.4 GHz (unlicensed)	Remote traffic control data communications
Dedicated short range communications (DSRC)	902-928 MHz LMS band (unlicensed); 2.4 GHz (unlicensed); 5.859-5.925 GHz (pending FCC approval)	Widely used in ETC and AVI system; IntelliDrive
Analog/Digital microwave	11, 23,31 GHz	Alternative for long-haul wireline transmission

Source: Yan, et. al. *TRR 1788*

Communications Systems for ITS Applications

## PROTOCOLS

## Terminology Review

- Media
  - A physical cable
  - Wireline or Wireless
- Protocol
  - A set of rules for transmitting data
  - Examples: DSL, Ethernet, TCP/IP
- Topology
  - A physical or logical arrangement of devices
  - Examples: Point-to-point, ring, star

3-29

## Protocols: The Big Picture

- Takes usable information and:
  - Breaks it into discrete chunks
  - Surrounds each chunk with additional stuff
    - Where it came from, where it's going, order
  - Sends it down the line
- At the other end:
  - Reads the stuff
  - Assembles back into usable information

## 5 Traits of Protocols

- Standard format for transmitting data between two devices
- Error checking
- Data compression
- Message has been sent
- Message has been received

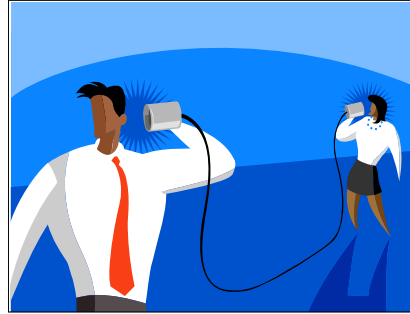

## Protocol Stacking

OSI 7-Layer Model

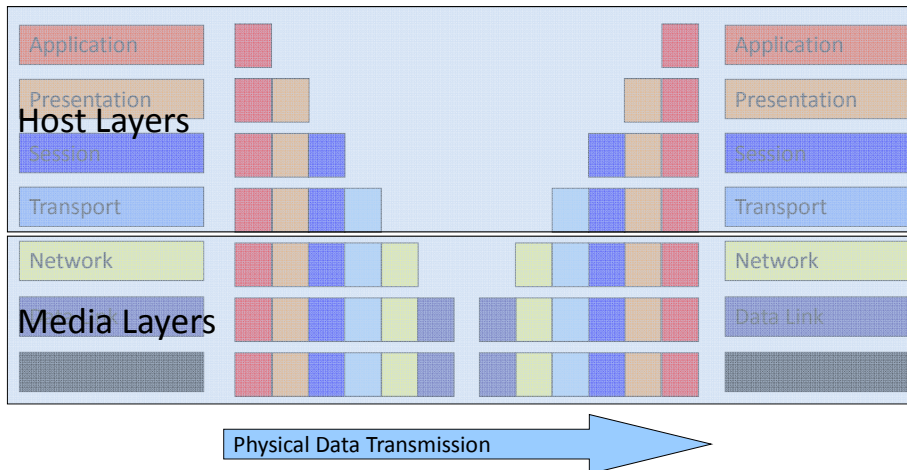

# Open System Interconnection (OSI) Reference Model Analogy

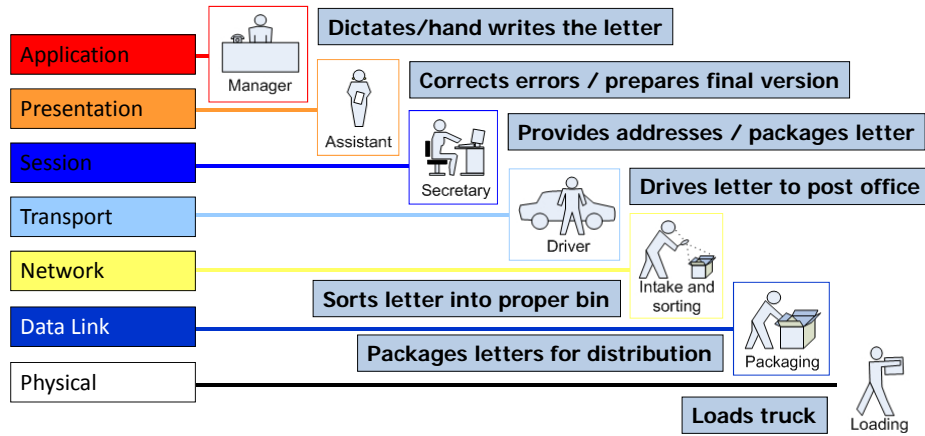

Adapted from: [www.wikipedia.org](http://www.wikipedia.org)

## OSI Analogy (cont.)

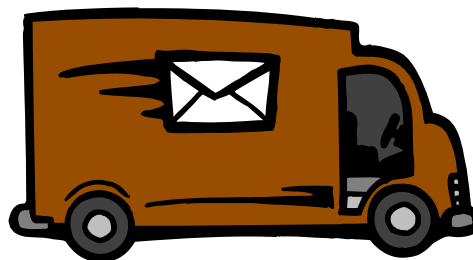

Physical Data Transmission →

Adapted from: [www.wikipedia.org](http://www.wikipedia.org)

## OSI Analogy (cont.)

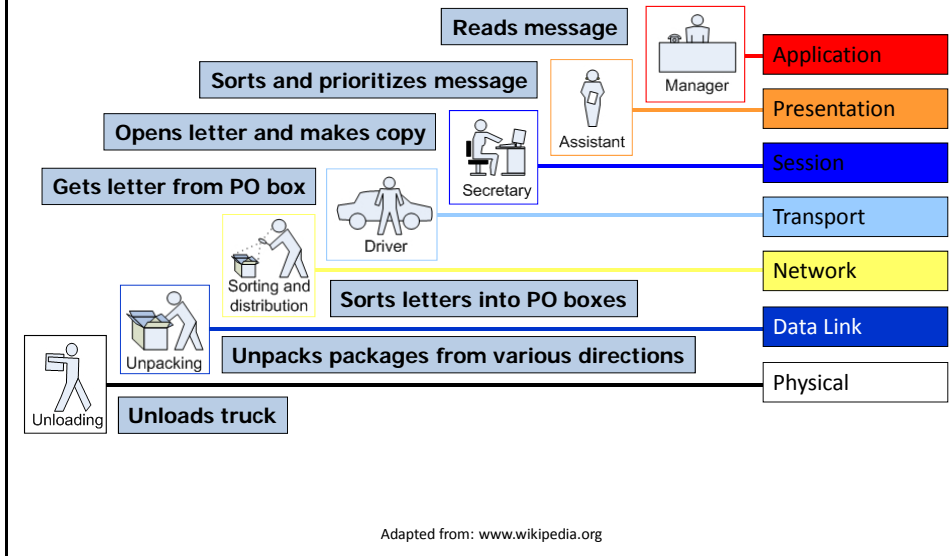

## Common ITS Protocols

- Serial
- Digital subscriber line (DSL)
- Frame relay
- Asynchronous transfer mode (ATM)
- Synchronous optical network (SONET)
- Transmission Control Protocol/Internet Protocol (TCP/IP)
- Ethernet

## TCP/IP

- Layered protocol
- TCP lives at Layer 4 (transport) of OSI Model
- IP lives at Layer 3 (network)
- Most universally accepted/used protocol
- Backbone of communication networks, such as the Internet
- Supported by virtually all other lower level protocols (protocol stacking)

## TCP – Transmission Control Protocol

- Sends data from one node on a network to another
- Establishes a connection to the other end
- Breaks information into packets
- Numbers and sends each packet
- Checks for delivery
- Processes packets in order (by number)
- Uses acknowledgements and resends to ensure proper delivery

## IP – Internet Protocol

- Considered a “connectionless” protocol
- Does not expect acknowledgements
- IP packet contains
  - Source address
  - Destination address
  - Protocol identifier
  - Checksum
  - Time To Live (TTL)

## Time To Live

- TTL is a mechanism for preventing packets of data from roaming around a network indefinitely
- If they did, network bandwidth would eventually go to zero
- The TTL value of a packet is decreased each time it crosses a router (aka a “hop”)
- When TTL = 0, the packet is discarded

## IP Addressing

- Two parts to an IP address
- Example:
  - Network ID = your street
  - Host ID = your house number
- Represented as dotted decimal notation
- Each group is called an octet

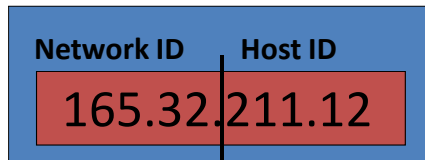

3.3.6

## Bits and Octets

Binary	Bit Value	Decimal
00000000	0	0
10000000	128	128
11000000	128 + 64	192
11100000	128 + 64 + 32	224
11110000	128 + 64 + 32 + 16	240
11111000	128 + 64 + 32 + 16 + 8	248
11111100	128 + 64 + 32 + 16 + 8 + 4	252
11111110	128 + 64 + 32 + 16 + 8 + 4 + 2	254
11111111	128 + 64 + 32 + 16 + 8 + 4 + 2 + 1	255

3-42



## IP Addressing

- Every device has a unique address
- Addresses are 32 bits in length
  - Example: 169.254.32.4
- Addresses are organized into “classes”
  - 1.x.x.x through 126.x.x.x = Class A
    - 126 networks with 16 million devices each
  - 128.0.x.x through 191.255.x.x = Class B
    - 16,384 networks with 65,000 devices each
  - 224.0.0.x through 239.255.255.x = Class C
    - 2 million networks with 254 hosts each

## Addressing on Different Classes

- Class A

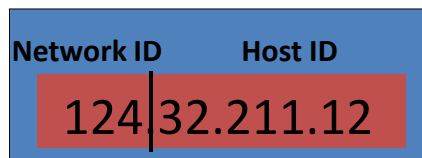

- Class B

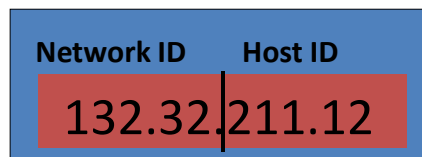

- Class C

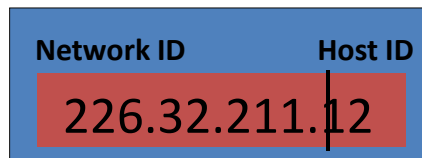

## Restricted Address Space

- 127.x.x.x – Network adapter diagnostics
- 127.0.0.1 – Local loop back
- Private networks
  - 10.x.x.x
  - 172.16.x.x - 172.31.x.x
  - 192.168.x.x
- 169.254.x.x – Automatic addressing

## Class D and Multicasting

- Class D (224.x.x.x through 239.x.x.x)
  - Reserved for multicasting
  - Overlaps with Class C addressing
  - Requires care in assigning multicast addresses
- Uses registration to send information to groups of devices
- Packets are replicated only when necessary (at diverge points on the network)

## IPv6 Addressing

- Next generation IP addressing
- Created to accommodate:
  - Increasing need
  - Dwindling supply
- 128 bit addresses (16 octets)
- $3.4 \times 10^{38}$  unique addresses
- Need for change slowed by conservation of existing address space
- Significant marketplace resistance to implementation

3.3.6

## Private Address Space

- Doesn't communicate directly to the Internet
- Conservation method for IPv4 addresses
- Works in conjunction with
  - NAT – Network Address Translation
  - DHCP – Dynamic Host Configuration Protocol

3-48

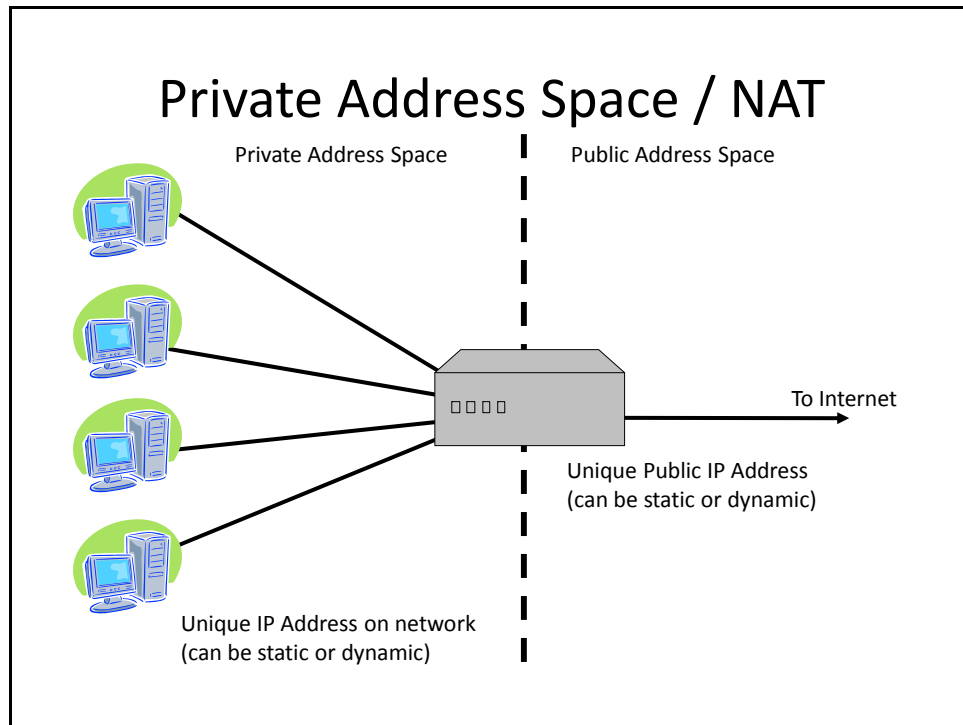

## Other Protocols

- Hypertext transfer protocol (HTTP)
- File transfer protocol (FTP)
- Simple object access protocol (SOAP)
- Simple network management protocol (SNMP)
- Network time protocol (NTP)
- Simple mail transfer protocol (SMTP)

## What About XML?

- Question: Is XML a protocol?
  - Technically, the answer is no
- What is it then?
  - It is a markup language
  - Emerging approach for transportation applications
  - Widely used by various industries
  - Mechanism for encoding data for exchange
  - All messages are described within tags

## HTML vs. XML

	HTML	XML
Tags do what:	Describe how the data will be formatted	Describe what the data are
Examples:	<code>&lt;b&gt;This is a bold tag&lt;/b&gt;</code> <code>&lt;i&gt;This is an italics tag&lt;/i&gt;</code>	<code>&lt;price&gt;\$2.50&lt;/price&gt;</code> <code>&lt;avail&gt;yes&lt;/avail&gt;</code>
End result:	<b>This is a bold tag</b> <i>This is an italics tag</i>	The price of the item is \$2.50 The item is available

# OSI 7-Layer Model and NTCIP

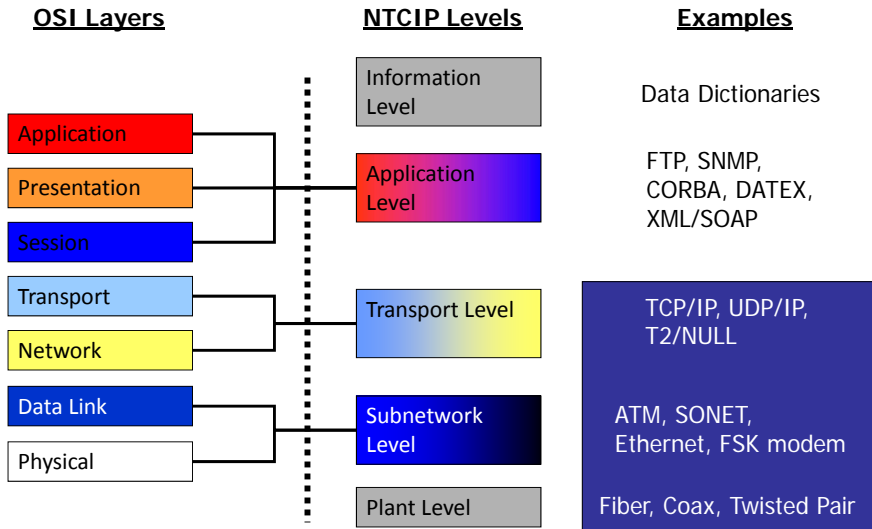

## NTCIP Protocols

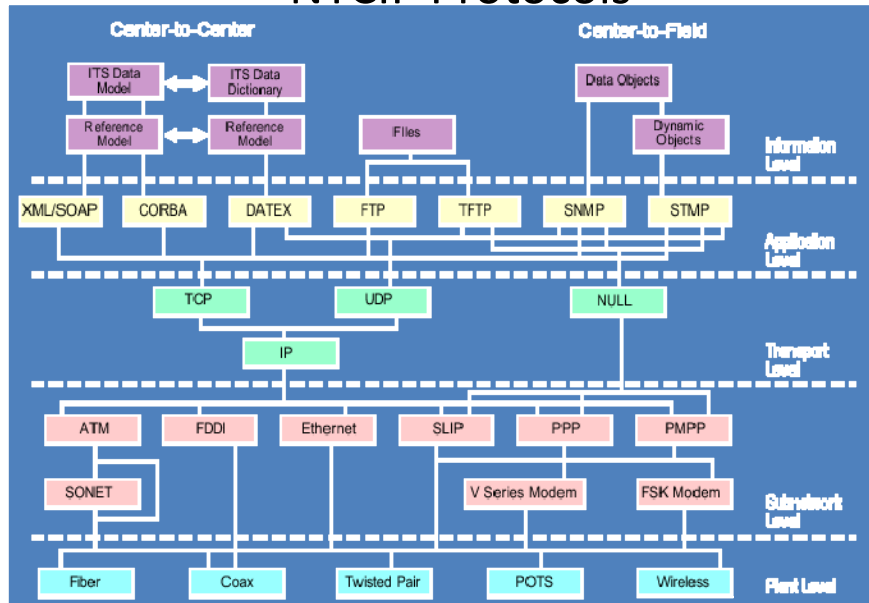

## Technology Choices

- Serial
- Plain Old Telephone Service (POTS)
- Integrated Services Digital Network (ISDN)
- Digital Subscriber Line (DSL)
- Cable Modem
- T-1/T-3 Services
- Asynchronous Transfer Mode (ATM)
- Synchronous Optical Network (SONET)
- Ethernet

## Serial

- Low (no?) cost
- Shorter distances
- “Simple” technology
- Prone to interference

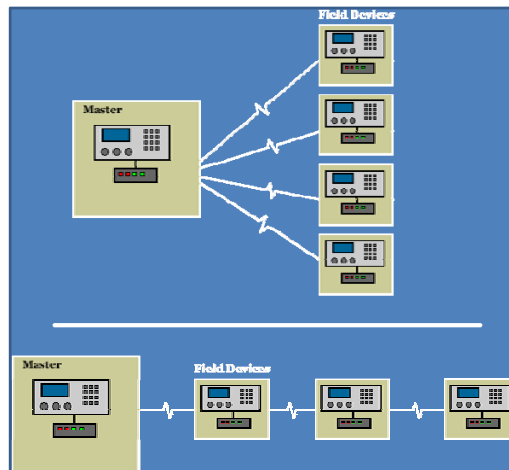
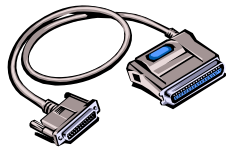

# POTS



- Technology has changed, basic principles have not
- Good for low data transmission rates (rates are regulated)
- Good for long distances

Supported Protocols	
<input checked="" type="checkbox"/>	TCP
<input checked="" type="checkbox"/>	IP
	ATM
	Frame Relay
	SONET
	Ethernet
<input checked="" type="checkbox"/>	PPP
	DSL

# POTS

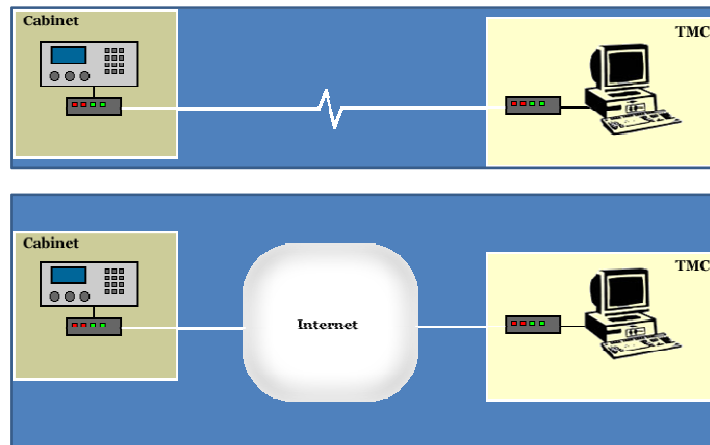



# ISDN

- Runs on standard phone lines
- “Integrated” voice and data
- All digital (higher bandwidth)
- Distance limited (not available everywhere)

Supported Protocols	
<input checked="" type="checkbox"/>	TCP
<input checked="" type="checkbox"/>	IP
	ATM
	Frame Relay
	SONET
	Ethernet
	PPP
	DSL

# ISDN

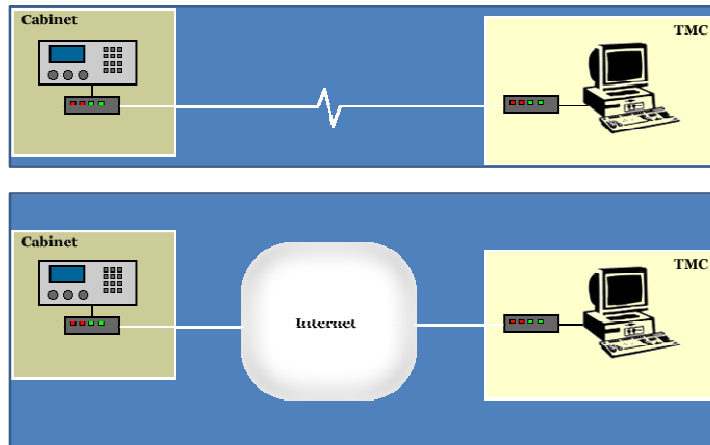

## DSL

- Outgrowth of ISDN – data only, faster
- Numerous types of DSL services
  - Not all are available everywhere
- Not as secure as others
- Distance limited

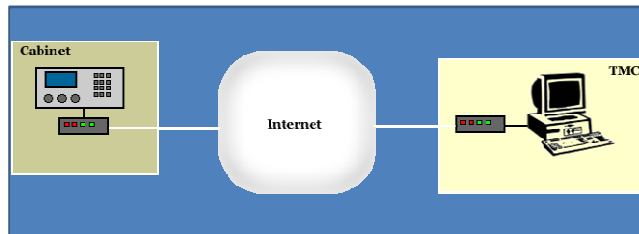

Supported Protocols	
<input checked="" type="checkbox"/>	TCP
<input checked="" type="checkbox"/>	IP
<input checked="" type="checkbox"/>	ATM
	Frame Relay
	SONET
	Ethernet
	PPP
<input checked="" type="checkbox"/>	DSL

## Cable Modem



- Media originally designed for TV services
- Data services developed later
- Higher transmission speeds
- Not distance limited

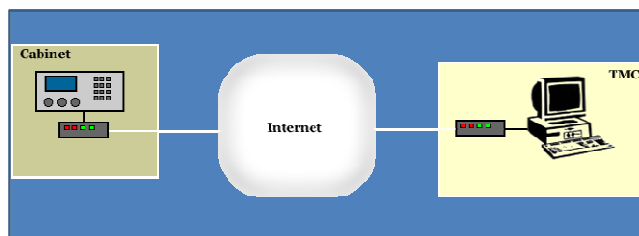

Supported Protocols	
<input checked="" type="checkbox"/>	TCP
<input checked="" type="checkbox"/>	IP
	ATM
	Frame Relay
	SONET
	Ethernet
	PPP
	DSL

## T-1/T-3 Services

- First implemented in 1960s
- Building block of dedicated voice and data services in North America
- Not distance limited
- More expensive
  - Pay for the line whether you use it or not (leased service)

Supported Protocols	
<input checked="" type="checkbox"/>	TCP
<input checked="" type="checkbox"/>	IP
	ATM
<input checked="" type="checkbox"/>	Frame Relay
	SONET
	Ethernet
	PPP
	DSL

## T-1/T-3 Services

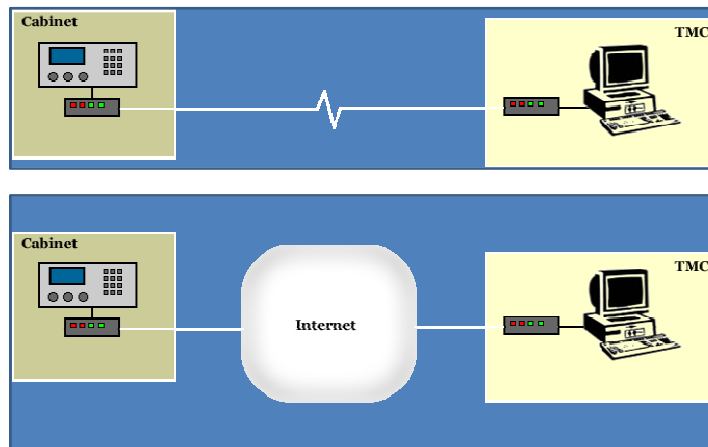

# ATM

- High bandwidth, low delay
- Packet switching technology
- Provided over copper or fiber optic cabling
- More expensive
- Higher learning curve

Supported Protocols	
<input checked="" type="checkbox"/>	TCP
<input checked="" type="checkbox"/>	IP
<input checked="" type="checkbox"/>	ATM
	Frame Relay
<input checked="" type="checkbox"/>	SONET
<input checked="" type="checkbox"/>	Ethernet
	PPP
	DSL

# ATM

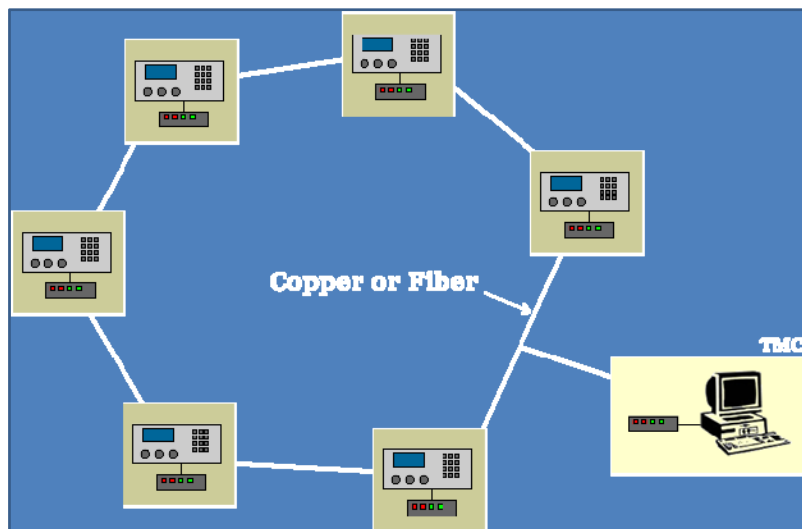

# SONET

- Replacement for copper-based transmissions
- Single fiber cable replaced hundreds of copper wires
- Very high speeds
- Most expensive

Supported Protocols	
<input checked="" type="checkbox"/>	TCP
<input checked="" type="checkbox"/>	IP
<input checked="" type="checkbox"/>	ATM
	Frame Relay
<input checked="" type="checkbox"/>	SONET
<input checked="" type="checkbox"/>	Ethernet
	PPP
	DSL

# SONET

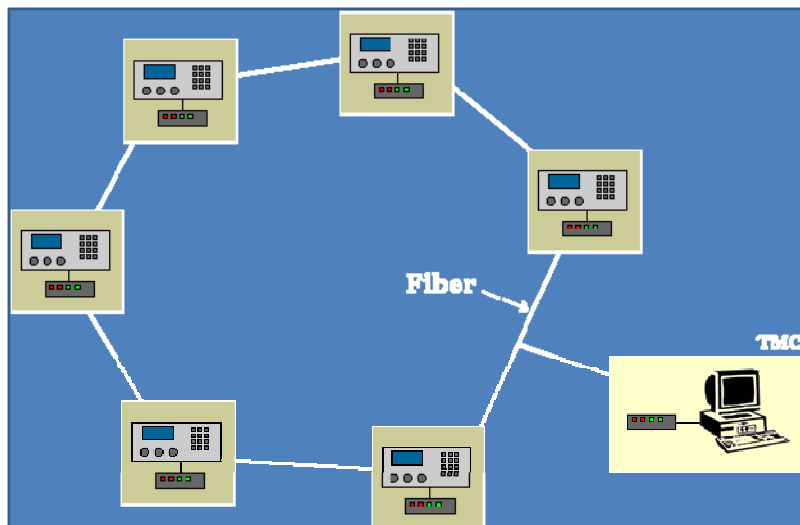

## Ethernet

- Developed for local computer networks
- IEEE “802” committee assigned task to develop international standard
- Rapidly evolving
- Supports all wiring types



Supported Protocols	
<input checked="" type="checkbox"/>	TCP
<input checked="" type="checkbox"/>	IP
<input checked="" type="checkbox"/>	ATM
	Frame Relay
	SONET
<input checked="" type="checkbox"/>	Ethernet
<input checked="" type="checkbox"/>	PPP
	DSL

## Ethernet

- Initially a shared communications backbone
- Data collisions were resolved by CSMA/CD algorithms
- Collision domain

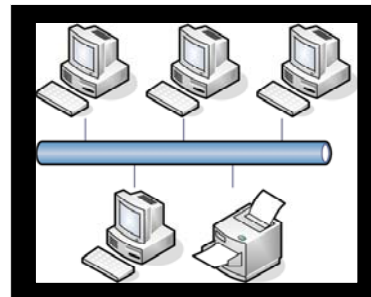

## Ethernet

- Full duplex switched Ethernet
- Devices do not “share” wires

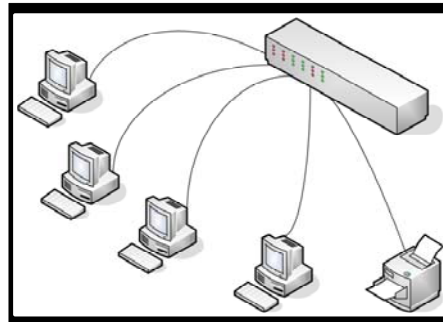

4-71

## Ethernet

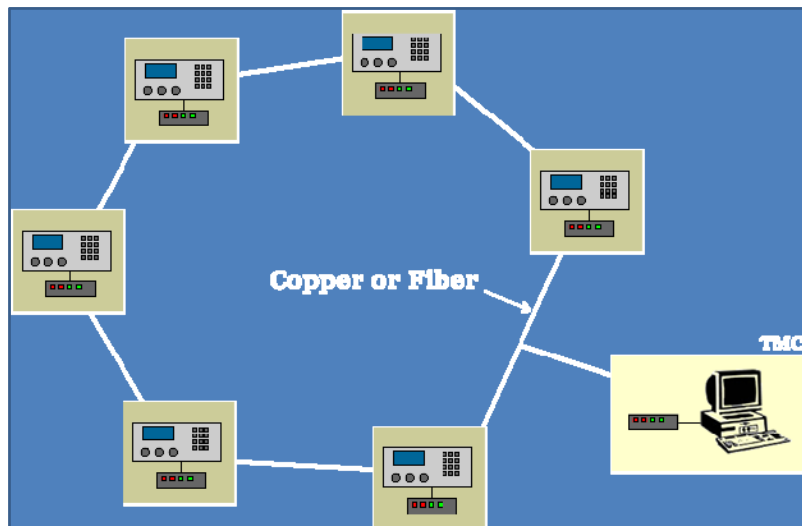

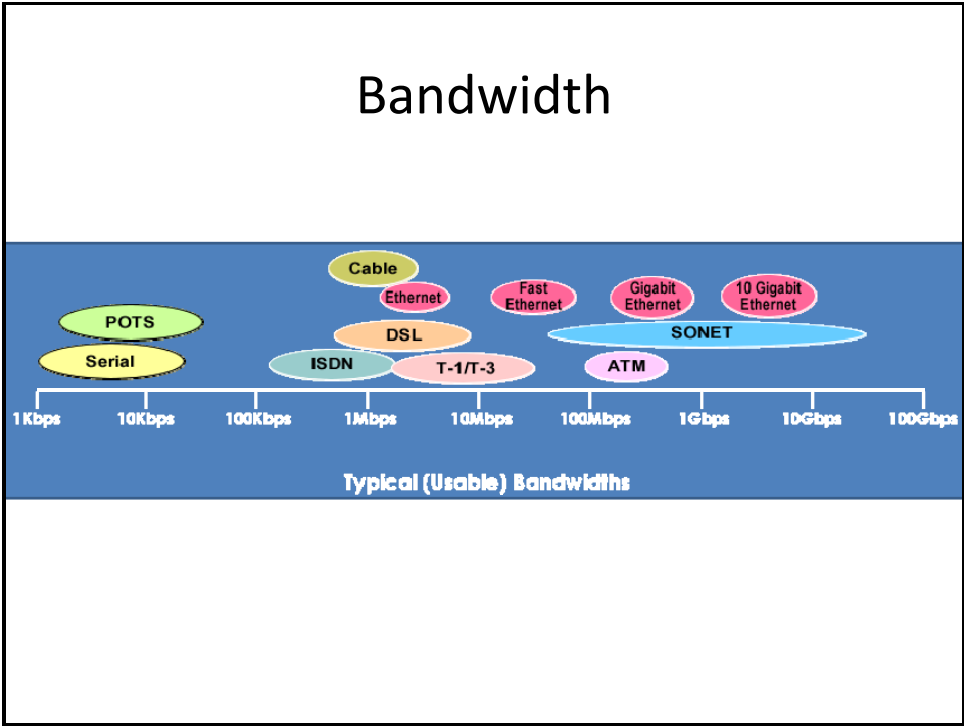
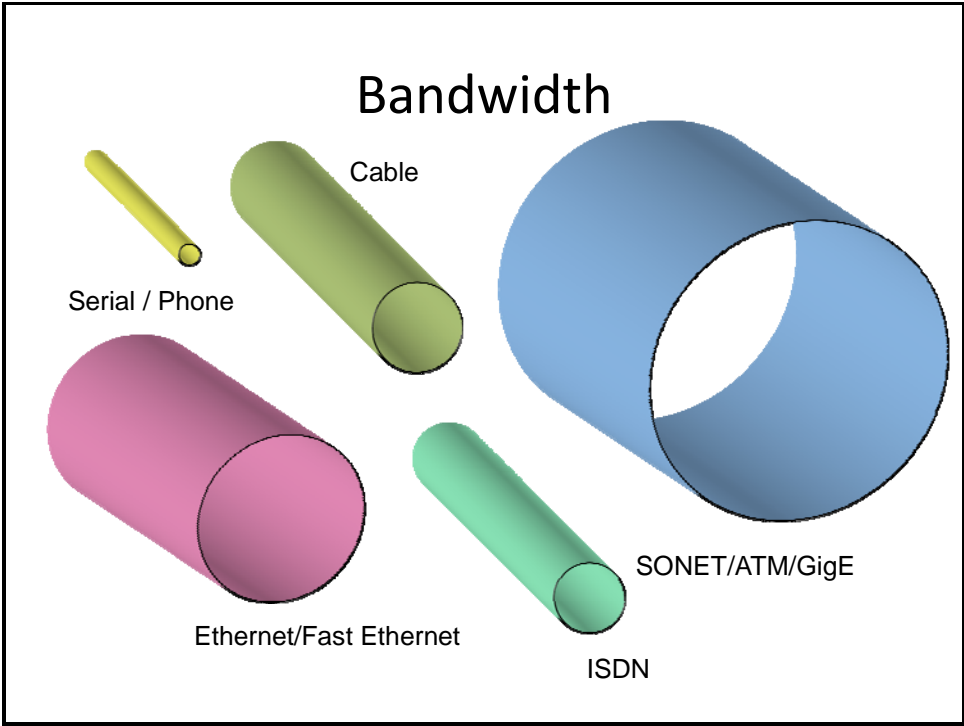



## Wiring Choices

Technology	Twisted Pair	Coaxial	Fiber
Serial	<input checked="" type="checkbox"/>		
POTS	<input checked="" type="checkbox"/>		
ISDN	<input checked="" type="checkbox"/>		
DSL	<input checked="" type="checkbox"/>		
Cable Modem		<input checked="" type="checkbox"/>	
T-1/T-3	<input checked="" type="checkbox"/>		<input checked="" type="checkbox"/>
ATM	<input checked="" type="checkbox"/>		<input checked="" type="checkbox"/>
Ethernet	<input checked="" type="checkbox"/>	<input checked="" type="checkbox"/> *	<input checked="" type="checkbox"/>
SONET			<input checked="" type="checkbox"/>

\* Not common

## Deployment Methods

Technology	Direct	Internet	Network
Serial	<input checked="" type="checkbox"/>		
POTS	<input checked="" type="checkbox"/>	<input checked="" type="checkbox"/>	
ISDN	<input checked="" type="checkbox"/>	<input checked="" type="checkbox"/>	
DSL		<input checked="" type="checkbox"/>	
Cable Modem		<input checked="" type="checkbox"/>	
T-1/T-3	<input checked="" type="checkbox"/>	<input checked="" type="checkbox"/>	
ATM			<input checked="" type="checkbox"/>
Ethernet			<input checked="" type="checkbox"/>
SONET			<input checked="" type="checkbox"/>

## Distance Limitations

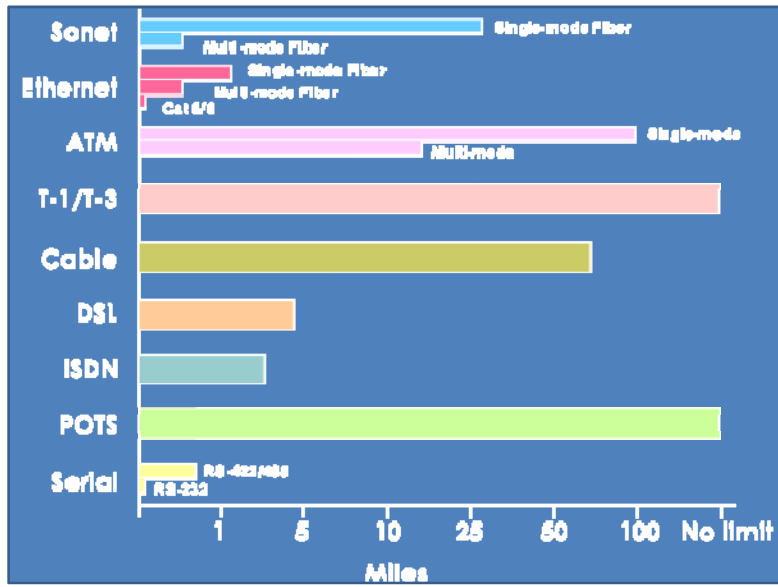

## Relative Costs

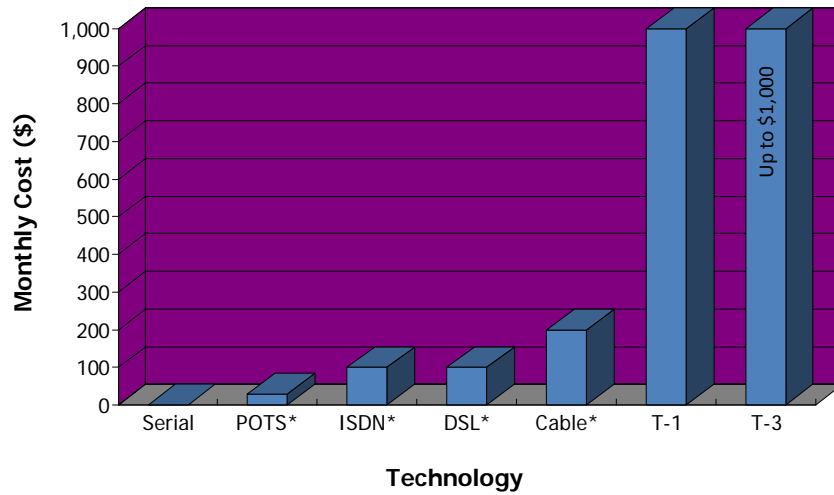

\* Per connection

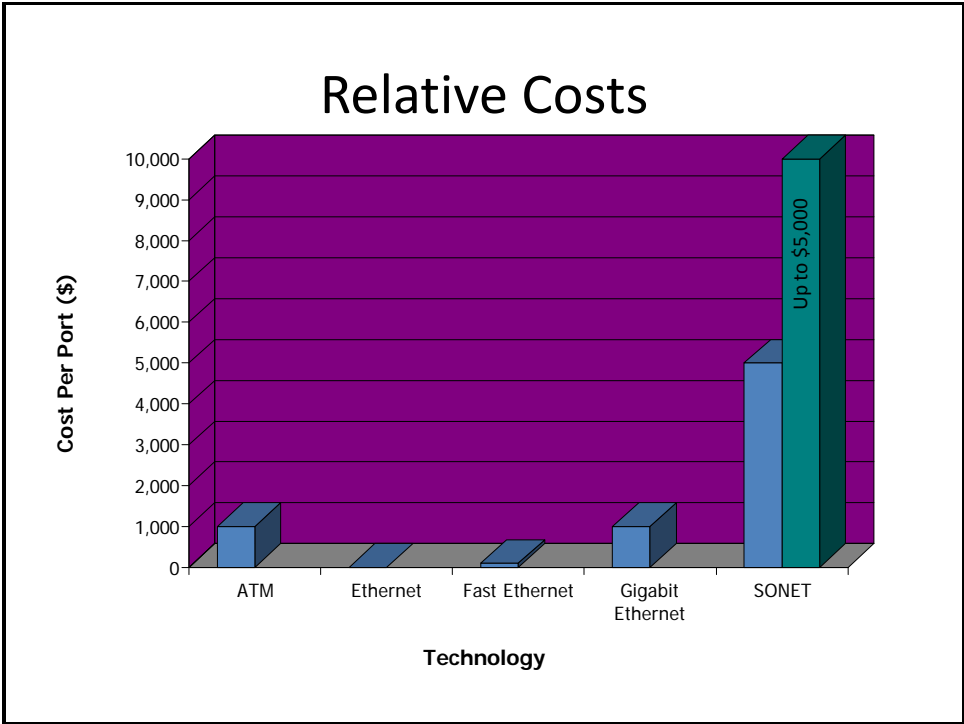

Communications Systems for ITS Applications

## ARCHITECTURES AND TOPOLOGY

# Architecture

- Topology describes arrangement of devices
- Architecture focuses on ITS component relationships (more abstract)

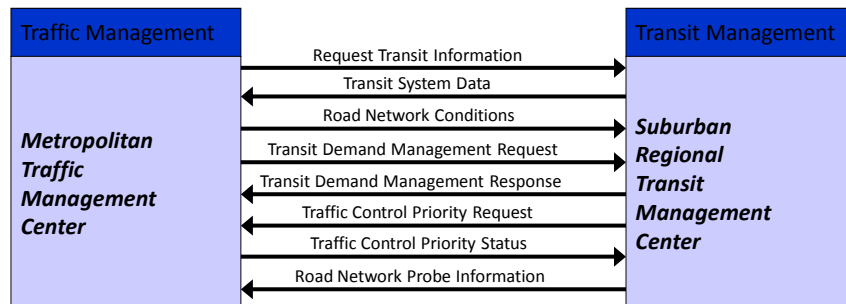

# National ITS Architecture

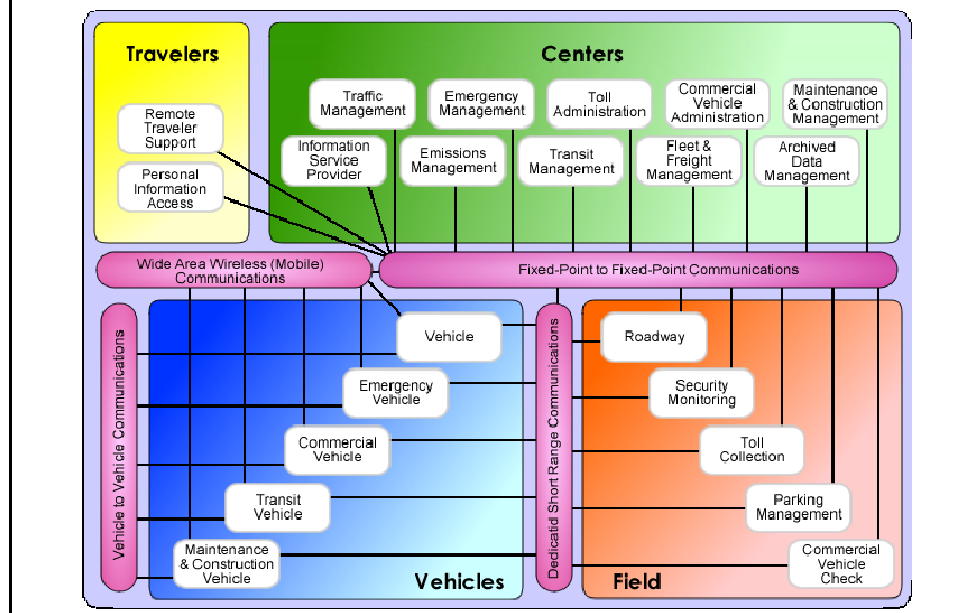

## Point-to-Point Topology

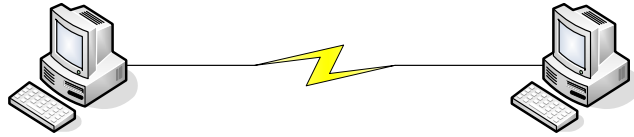

- Direct connection between two devices
  - Direct
  - Internet
- Example: Dial-up connection

## Star Topology

- Each device connected to a central node (switch, hub)
- Example: small business computer network

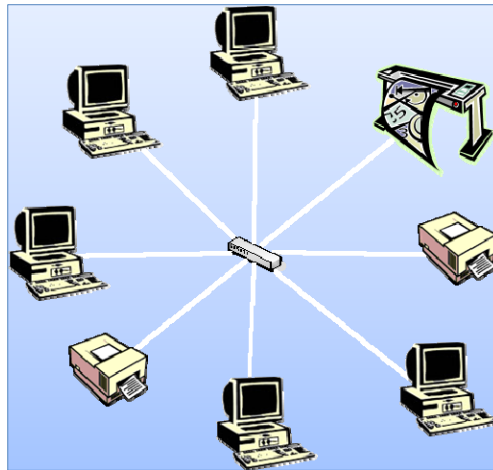

## Ring Topology

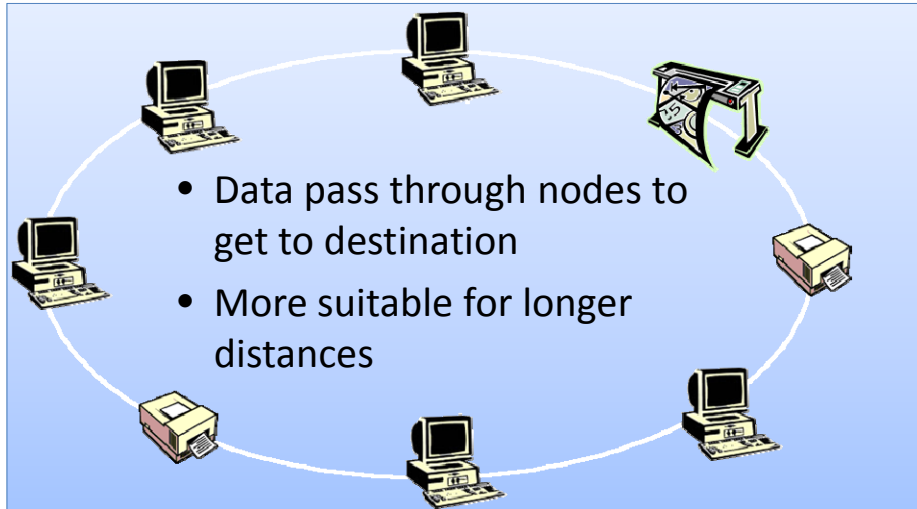

## Bus Topology

- All nodes connected on a single line
- One node is a master at any given time
- Only the master can send data

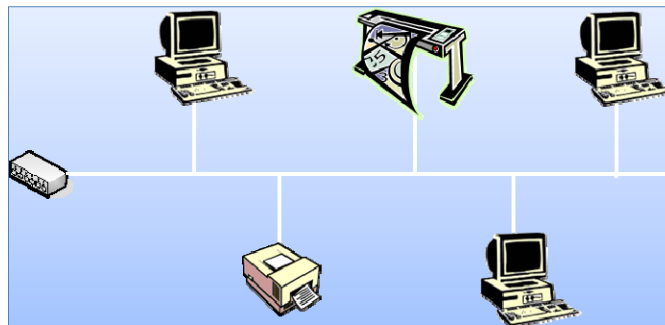

## Hybrid Topology

- Combination of two or more topologies

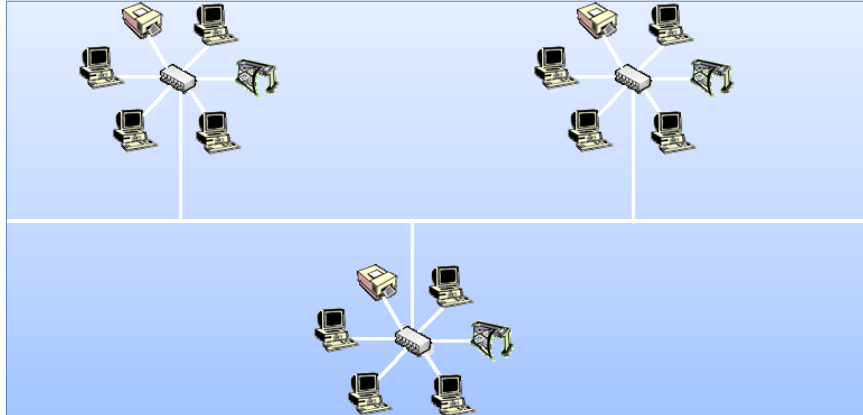

## Modern Networks

- Multiple topologies
- Provides redundancy

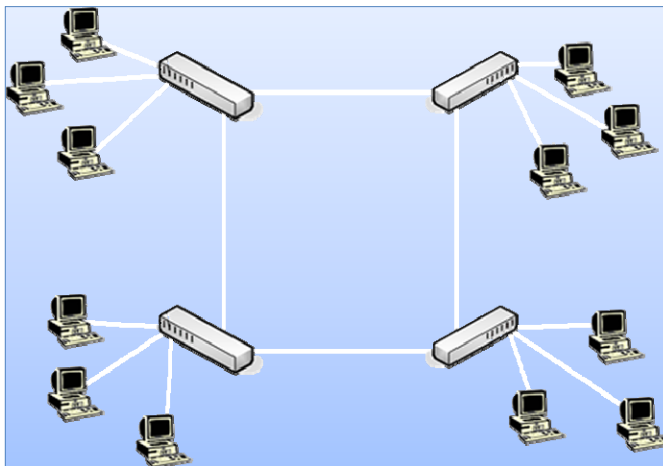

## Hubs, Routers, and Switches

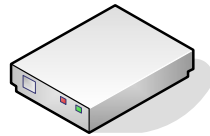

Modem

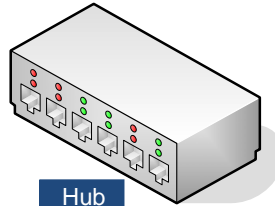

Hub

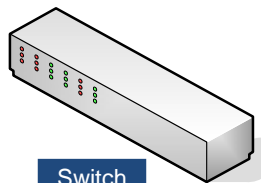

Switch

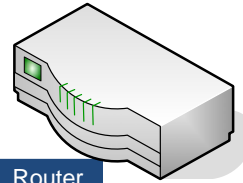

Router

### Modem (\$)

- Modulator / Demodulator
- Converts analog signal to digital and vice versa

### Hub (\$)

- Not an “intelligent” device
- Information is not routed to a specific device



## Switch (\$\$)

- “Intelligent” hub
- Information delivered to specific device
- Managed or unmanaged

## Router (\$\$\$)

- Similar to switch, but for between networks
- Information delivered to specific network

## Hardened Equipment

- Field cabinets are not cooled
- Harsh environment for electronic equipment
- Specifications for:

- Voltage
- Frequency
- Temperature
- Humidity
- Vibration
- Shock

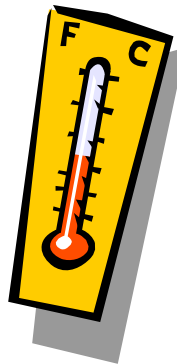

## Security

- Cannot be ignored
- Multiple components:
  - Physical access
  - Device security
  - Network design
  - Data encapsulation
- Trade-off with trust
  - Open networks easier to use, but more exposed
- Security monitoring



## Spanning Tree

- Networks are:
  - Interconnected, with multiple paths from point A to point B
  - Loops can occur
- Spanning tree protocol (STP) used to prevent loops by calculating “shortest” path
- “shortest” may be measured in multiple ways
  - Typically – minimum time delay
- Also used to recalculate paths in a line failure

## Spanning Tree Illustrated

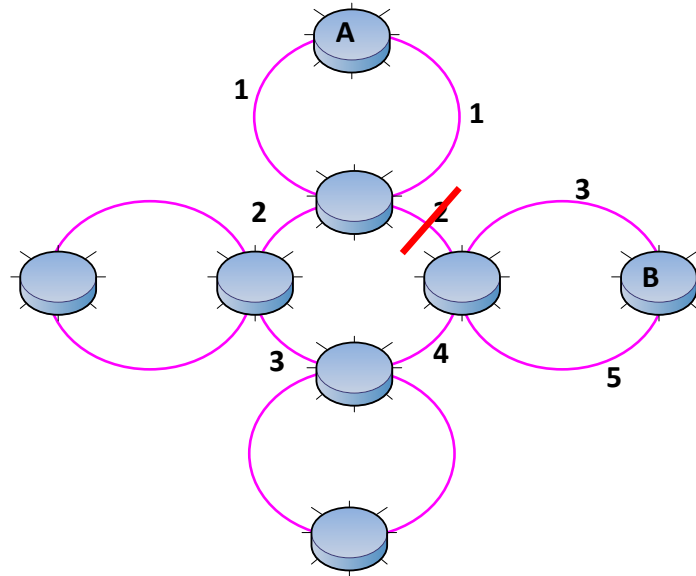

## Tunneling

- A network protocol which enables data from one network to be temporarily sent across another network.
- Used for:
  - Security
  - Sharing bandwidth
  - Extending networks over long distances
- VPN (Virtual Private Network) is one example



## **Appendix E: Lecture Slides for Module 5. Evaluating ITS Projects**



# Evaluating ITS Projects

## Module 5

### References

- RITA ITS Evaluation Guidelines
- Traffic Analysis Toolbox Series (<http://ops.fhwa.dot.gov/trafficanalysisitools/index.htm>)
  - Volume I: Traffic Analysis Tools Primer
  - Volume II: Decision Support Methodology for Selecting Traffic Analysis Tools
  - Volume III: Guidelines for Applying Traffic Microsimulation Modeling Software
  - Volume IV: Guidelines for Applying CORSIM Microsimulation Modeling Software
  - Volume V: Traffic Analysis Toolbox Case Studies – Benefits and Applications
- *Incorporating ITS into the Transportation Planning Process* (NCHRP Web-Only Document 118)

US DOT's Research and Innovative Technology Administration  
(RITA) Recommended Evaluation Process

- Step 1. Form the Evaluation Team
- Step 2. Develop an Evaluation Strategy
- Step 3. Develop an Evaluation Plan
- Step 4. Develop one or more Detailed Test Plan
- Step 5. Collect and Analyze Data and Information
- Step 6. Prepare Final Report

## Key Strategic Goals and Performance Measures of ITS

Goal Area	Measures
Safety	<ul style="list-style-type: none"><li>• Reduction in overall crash rate</li><li>• Reduction in fatality rate</li><li>• Reduction in injury rate</li></ul>
Mobility	<ul style="list-style-type: none"><li>• Reduction in travel time delay</li><li>• Reduction in travel time variability</li></ul>
Efficiency	<ul style="list-style-type: none"><li>• Increase in freeway and arterial throughput</li></ul>
Productivity	<ul style="list-style-type: none"><li>• Cost savings</li></ul>
Energy and the Environment	<ul style="list-style-type: none"><li>• Decrease in vehicle emissions</li><li>• Decrease in vehicle energy consumption</li></ul>
Customer Satisfaction	<ul style="list-style-type: none"><li>• Increase customer satisfaction</li></ul>

# Criteria for Selecting Traffic Analysis Tool

Analysis Context: Planning, Design, or Operations/Construction						
1	2	3	4	5	6	7
Geographic Scope	Facility Type	Travel Mode	Management Strategy	Traveler Response	Performance Measures	Tool/Cost-Effectiveness
What is your study area?	Which facility types do you want to include?	Which travel modes do you want to include?	Which management strategies should be analyzed?	Which traveler responses should be analyzed?	What performance measures are needed?	What operational characteristics are necessary?
<ul style="list-style-type: none"> <li>• Isolated Location</li> <li>• Segment</li> <li>• Corridor/Small Network</li> <li>• Region</li> </ul>	<ul style="list-style-type: none"> <li>• Isolated Intersection</li> <li>• Roundabout</li> <li>• Arterial</li> <li>• Highway</li> <li>• Freeway</li> <li>• HOV Lane</li> <li>• HOV Bypass Lane</li> <li>• Ramp</li> <li>• Auxiliary Lane</li> <li>• Reversible Lane</li> <li>• Truck Lane</li> <li>• Bus Lane</li> <li>• Toll Plaza</li> <li>• Light Rail Line</li> </ul>	<ul style="list-style-type: none"> <li>• SOV</li> <li>• HOV (2, 3, 3+)</li> <li>• Bus</li> <li>• Rail</li> <li>• Truck</li> <li>• Motorcycle</li> <li>• Bicycle</li> <li>• Pedestrian</li> </ul>	<ul style="list-style-type: none"> <li>• Freeway Mgmt</li> <li>• Arterial Intersections</li> <li>• Arterial Mgmt</li> <li>• Incident Mgmt</li> <li>• Emergency Mgmt</li> <li>• Work Zone</li> <li>• Spec Event</li> <li>• APIS</li> <li>• ATIS</li> <li>• Electronic Payment</li> <li>• RVX</li> <li>• CVO</li> <li>• AVCS</li> <li>• Weather Mgmt</li> <li>• TDM</li> </ul>	<ul style="list-style-type: none"> <li>• Route Diversion</li> <li>• Pre-Trip - En-Route</li> <li>• Mode Shift</li> <li>• Departure Time Choice</li> <li>• Destination Change</li> <li>• Induced/Tongue Demand</li> </ul>	<ul style="list-style-type: none"> <li>• LOS</li> <li>• Speed</li> <li>• Travel Time</li> <li>• Volume</li> <li>• Travel Distance</li> <li>• Ridership</li> <li>• AVO</li> <li>• v/c Ratio</li> <li>• Density</li> <li>• VMT/FMT</li> <li>• VHT/PHT</li> <li>• Delay</li> <li>• Queue Length</li> <li>• # Stops</li> <li>• Crashes/Duration</li> <li>• IT Reliability</li> <li>• Emissions/Fuel Consump</li> <li>• Noise</li> <li>• Mode Split</li> <li>• Benefit/Cost</li> </ul>	<ul style="list-style-type: none"> <li>• Tool Capital Cost</li> <li>• Effort (Cost/Training)</li> <li>• Ease of Use</li> <li>• Popular/Well-Trusted</li> <li>• Hardware Requirements</li> <li>• Data Requirements</li> <li>• Computer Run Time</li> <li>• Post-Processing</li> <li>• Documentation</li> <li>• User Support</li> <li>• Key Parameters User Defeable</li> <li>• Default Values</li> <li>• Integration</li> <li>• Animation/Presentation</li> </ul>

Source: *Traffic Analysis Toolbox Volume I: Traffic Analysis Tools Primer*

## Evaluation Tools

- Sketch-planning methodologies
- Travel demand/Planning models
- Analytical/deterministic tools
- Traffic optimization tools
- Macroscopic simulation models
- Mesoscopic models



## Sketch-Planning Techniques

- Generally straightforward, parametric, or spreadsheet analysis to approximate potential impacts
- Potential Uses
  - Large number of options to evaluate (screen alternatives)
  - Impacts localized
  - Relatively small projects

## Screening for ITS (SCRITS)

- Spreadsheet tool for estimating user benefits and screening options
- Developed by SAIC
- Daily analysis of 16 different types of ITS (fixed)
- Estimates changes in
  - Vehicle hour of travel (VHT)
  - Vehicle miles of travel (VMT)
  - Emissions
  - Vehicle operating costs
  - Energy consumption
  - Number of accidents
  - User economic benefits
- Doesn't estimate system operating or capital costs

## ITS Alternatives Supported in SCRITS

- CCTV
- Detection
- HAR
- Dynamic Message Signs
- Pager-Based Systems
- Kiosks
- CVO Kiosks
- Traffic Information through the Internet
- AVL systems for Buses
- Electronic Fare Collection for Buses
- Signal Priority Systems for Buses
- Electronic Toll Collection
- Ramp Metering
- Weigh in Motion
- Highway/Rail Grade Crossing Applications
- Traffic Signalization Strategies

## Intelligent Transportation Systems Deployment Analysis System (IDAS)

- Sketch-Planning Tool
- Features of IDAS
  - Works with the output of existing transportation planning models;
  - Compares and screens ITS deployment alternatives;
  - Estimates the impacts and traveler responses to ITS;
  - Develops inventories of ITS equipment needed for proposed deployments and identifies cost sharing opportunities;
  - Estimates life-cycle costs including capital and O&M costs for the public and private sectors;
  - Provides documentation for transition into design and implementation.

## ITS Components Evaluated by IDAS

- Arterial Traffic Management Systems
  - Isolated Traffic Actuated
  - Pre-timed Coordinated
  - Actuated Coordinated
  - Central Control
  - Emergency Veh. Priority
  - Transit Priority
- Freeway Management Systems
  - Pre-set Ramp Metering
  - Traffic Actuated Ramp Metering
  - Central Control Ramp Metering

## ITS Components Evaluated by IDAS (cont.)

- Advance Public Transit Systems
  - Fixed Route Transit
    - Automated Scheduling
    - AVL
    - Automated Scheduling + AVL
    - Security Systems
  - Paratransit
    - Automated Scheduling
    - AVL
    - Automated Scheduling + AVL
- Incident Management
  - Detection / Verification
  - Response / Management
  - Combination
- Electronic Payment Systems
  - Electronic Transit Fare Payment
  - Basic Electronic Toll Collection

## ITS Components Evaluation by IDAS (cont.)

- Regional Multimodal Traveler Information
  - HAR
  - Freeway DMS
  - Transit DMS
  - Telephone-based Traveler Information Systems
  - Web/Internet-based Traveler Information Systems
  - Kiosk w/ Multimodal Traveler Information
  - Kiosk with Transit-only Traveler information
  - Handheld Personal Device – Traveler Information Only
  - Handheld Personal Device – Traveler Information w/ Route Guidance
  - In-vehicle – Traveler Information Only
  - In-vehicle – Traveler Information w/ Route Guidance
- Commercial Vehicle Operations
  - Electronic Screening
  - Weigh-in-Motion
  - Electronic Clearance – Credentials
  - Electronic Clearance – Safety Inspection
  - Electronic Screening/Clearance Combined
  - Safety Information Exchange
  - On-board Safety Monitoring
  - Electronic Roadside Safety Inspection
  - Hazardous Material Incident Response
- Advance Vehicle Control and Safety Systems
  - Motorist Warning – Ramp Rollover
  - Motorist Warning – Downhill Speed
  - Longitudinal Collision Avoidance
  - Lateral Collision Avoidance
  - Intersection Collision Avoidance
  - Vision Enhancement for Crashes
  - Safety Readiness

## ITS Components Evaluation by IDAS (cont.)

- Railroad Grade Crossing Monitors
- Emergency Management Services
  - Emergency Vehicle Control Service
  - Emergency Vehicle AVL
  - In-vehicle Mayday System
- Supporting Deployments
  - Traffic Management Center
  - Transit Management Center
  - Emergency Management Center
  - Traffic Surveillance – CCTV
  - Traffic Surveillance – Loop Detectors
  - Traffic Surveillance – Probe System
  - Basic Vehicle Communication
  - Roadway Loop Detector
  - Information Service Provider Center

## IDAS Model Structure

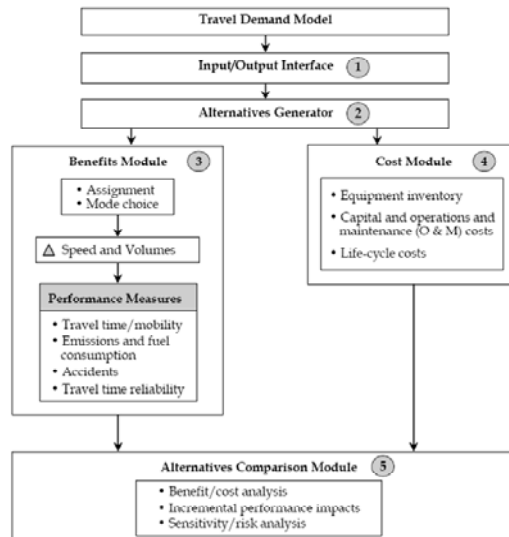

## IDAS Performance Measures

- Vehicle miles of Travel (VMT)
- Vehicle hours of Travel (VHT)
- Average Speed
- Person hours of travel (PHT)
- Number of person trips
- Number of accidents
  - Fatality
  - Injury
  - Property damage only
- Travel Time Reliability (hours of unexpected delay)
- Fuel Consumption (gallons)
- Emissions
  - Hydrocarbon and reactive organic gases
  - Carbon monoxide
  - Oxides of nitrogen
  - PM10
  - Carbon dioxide
  - Sulfur dioxide

## IDAS Benefit/Cost Summary

- Annual Benefits
  - Change in user mobility
  - Change in user travel time
    - In-vehicle
    - Out-of-vehicle
    - Travel time reliability
  - Change in cost paid by users
    - Fuel costs
    - Non-fuel operating costs
  - Change in external costs
  - Change in public agencies' costs
  - Other calculated benefits
  - User defined additional benefits
- Annual costs
  - Average annual private sector costs
  - Average annual public sector costs
- Net benefits (annual benefits minus annual costs)
- B/C Ratio (annual benefits / annual cost)

## Potential Applications for IDAS

- Deployment of regional ITS architectures
- Statewide, regional, and local ITS plans
- ITS alternative analysis for long-range planning
- ITS strategies for corridor studies
- Evaluation of ITS components or systems
- ITS strategic plans or pre-deployment studies

## IDAS Demo

- Demonstration of IDAS

## Travel Demand / Planning Models

- Forecast average (steady-state) travel and transportation demand and associated impacts over a given time period (daily, peak period, etc.)
- Use some variant of four-step method (trip generation, trip distribution, mode split, and assignment)
- Good for capturing long-range impacts at regional level
- Combined with sketch-planning techniques or post-processing to analyze ITS impacts
- Potential applications
  - Strategies that impact capacity
  - Strategies that cause mode shift

## Dynamic Traffic Assignment

- Fundamental Features
  - Time-varying traffic flow
  - Travel behavior decisions (mode, departure time, route choices) dependent upon traffic conditions in the network
- Result
  - Traffic conditions “more representative” of actual conditions
  - Traveler behavior updated in response to information
  - Dynamic OD estimation and prediction
  - Predict future travel conditions

## DYNASMART

- One model developed by FHWA
- Planning level model used to evaluate ITS improvements
- Dynamic
- Network
- Assignment
- Simulation
- Model for
- Advanced
- Road
- Telematics
- Two forms
  - P → Planning Version
  - X → Real-Time Detector Data



## Principal Features of DYNASMART

- Micro-simulation of individual trip-making decisions
  - Route departure time and mode
  - User responses to varying types of information (such as traveler information, congestion pricing, etc.)
- Hybrid traffic simulation approach – individual vehicles “move” based on speed-density curves
- Includes ability to load trip chains – a trip with several intervening stops with associated duration
- Multiple user classes in terms of:
  - Vehicle operating performance (e.g., trucks, buses, cars)
  - Information availability and type
  - User behavior rules and response to information
- Representation of traffic processes at intersections (stop and signal control)

## Potential Applications of DYNASMART

- Assessing infrastructure investments (signals, HOV/HOT lanes, etc.)
- Determining network congestion pricing schemes
- Evaluating ITS deployment alternatives and their geographic coverage (DMS location, information strategies, etc.)
- Verifying incentive strategies for work zone management (shift work to weekend or nights)
- Planning transit/bus routes or services
- Air quality conformity analysis
- Evacuation planning and control strategies

## DYNASMART Demo

- Demonstration of DYNASMART

## Analytical/Deterministic Models

- Practitioner enters data and after a sequence of processes, produces a single answer
  - Macroscopic – average performance over defined interval (15 minutes or 1 hour)
  - Deterministic – same input always produces same result
  - Static – do not deal with transition from one state to another (i.e., growth of congestion)
- Example: Highway Capacity Manual
- Major Advantage – quickly predict capacity, density, speed, delay, and queuing

## Potential Application of Analytical/Deterministic Models

- Analyzing performance of small-scale or isolated improvements (e.g., intersection, arterial, freeway ramp, etc.)
- Limited in ability to analyze network or system effects

## Macroscopic Simulation Models

- Traffic behavior based on deterministic relationships of flow, speed, and density
- Analysis takes place on a section-by-section basis (as opposed to at the individual vehicle level)
- Originally developed to model traffic in distinct transportation subnetworks (freeways, corridors, etc.)
- Vehicles considered as “platoons”

## Mesosopic Simulation

- Combine properties of both microscopic and macroscopic simulation
  - Individual vehicle behavior is modeled
  - Movements governed by macroscopic principles (i.e., speed-density relationships)
- DYNASMART example of Mesoscopic model

## Microscopic Simulation

- Simulates the movement of individual vehicles based on car-following and lane-changing theories
- Stochastic – vehicles enter network using a statistical distribution
- Vehicles tracked in brief time intervals (second or subsecond)
- Upon generation, each vehicle assigned a destination, a vehicle type, and a driver type
- Vehicle operating characteristics influenced by geometric conditions (grades, etc.)
- Traffic control (e.g., traffic signals) can be explicitly modeled

## Potential Applications of Microscopic Simulation

- Important to capture traffic changes over time
- Examine improvements at fine level of detail
- ITS Applications
  - Unusual incidents on system
  - Availability of information to specific travelers
  - Traffic control modifications (signal timing, ramp meterings, transit priority, HOV operations, incident responses, etc.)

## Steps in Properly Apply Microscopic Simulation Model

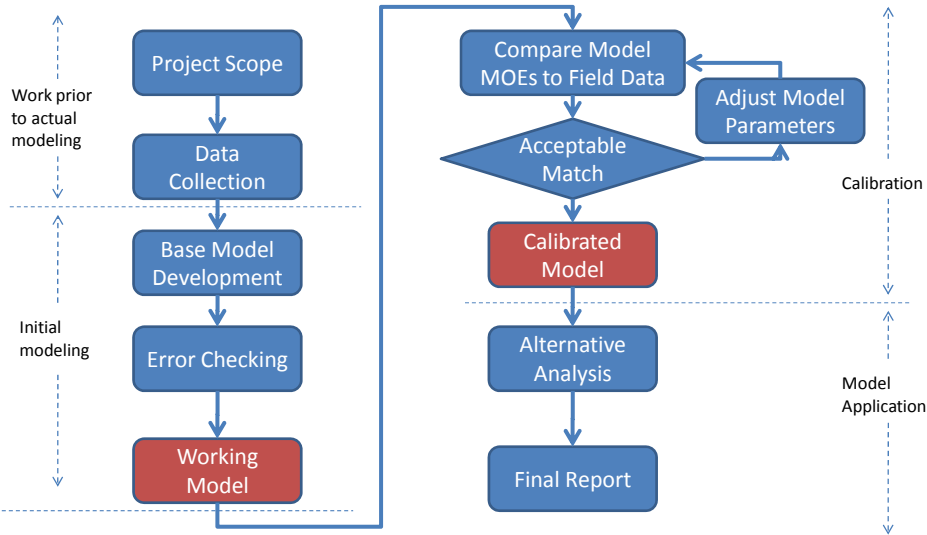

## Examples of Microscopic Simulation

- CORSIM Demo
- VISSIM Demo

## NGSIM

- Next Generation Simulation (NGSIM)
- Public-private partnership
- FHWA will support the development of behavior algorithms, validation datasets, and fundamental logic
- Open source
- <http://ngsim.fhwa.dot.gov/>

## Picking the Right Tool for the Job

Planning Needs	Operational Analysis Tools/Methods
Needs assessment/ deficiency analysis	<ul style="list-style-type: none"> <li>• Travel demand forecasting models</li> <li>• Deterministic models</li> <li>• Traffic signal optimization models</li> <li>• Simulation</li> <li>• Archived operations data</li> <li>• Operations-oriented performance metrics</li> </ul>
Preliminary screening	<ul style="list-style-type: none"> <li>• Sketch planning tools</li> </ul>
Alternative analysis	<ul style="list-style-type: none"> <li>• Sketch planning tools</li> <li>• Travel demand forecasting models</li> <li>• Simulation</li> </ul>
Strategic ITS planning	<ul style="list-style-type: none"> <li>• Sketch planning tools</li> <li>• Travel demand forecasting models</li> </ul>
Project scoring/ranking/ prioritizing	<ul style="list-style-type: none"> <li>• Travel demand forecasting models</li> <li>• Deterministic models</li> <li>• Operations-oriented performance metrics</li> </ul>

Source: *Statewide Opportunities for Linking Planning and Operations*

## Picking the Right Tool for the Job

Planning Needs	Operational Analysis Tools/Methods
Corridor and environmental analysis	<ul style="list-style-type: none"> <li>• Travel demand forecasting models</li> <li>• Deterministic models</li> <li>• Traffic signal optimization models</li> <li>• Simulation</li> </ul>
Planning for non-recurring congestion	<ul style="list-style-type: none"> <li>• Sketch planning tools</li> <li>• Travel demand forecasting models</li> <li>• Simulation</li> </ul>
Performance monitoring	<ul style="list-style-type: none"> <li>• Deterministic models</li> <li>• Traffic signal optimization tools</li> <li>• Archived operations data</li> <li>• Operations-oriented performance metrics</li> </ul>
Evaluation of deployed projects	<ul style="list-style-type: none"> <li>• Sketch planning tools</li> <li>• Travel demand forecasting models</li> <li>• Archived operations data</li> <li>• Operations-oriented performance metrics</li> </ul>

Source: *Statewide Opportunities for Linking Planning and Operations*

## Laboratory Exercise

- Use IDAS to conduct alternatives analysis of Bryan/College Station Mobility Initiative Strategic Areas





University Transportation Center for Mobility

Texas Transportation Institute

The Texas A&M University System

College Station, TX 77843-3135

Tel: 979.845.2538 Fax: 979.845.9761

[utcm.tamu.edu](http://utcm.tamu.edu)

